



# **Operator's Manual**

## **Model 2500A**

### **PalmSAT®**

**Pulse Oximeter with Alarms**

**CE 0123**

**English**

**CAUTION: Federal law (USA) restricts this device to sale by or on the order of a licensed practitioner.**



**Consult Instructions for Use.**

Nonin reserves the right to make changes and improvements to this manual and the products it describes at any time, without notice or obligation.

 **Nonin Medical, Inc.**  
13700 1st Avenue North  
Plymouth, MN 55441, USA

**Phone:** + 1 (763) 553-9968  
800-356-8874 (USA and Canada)  
**E-mail:** info@nonin.com

 **Nonin Medical B.V.**  
Doctor Paul Janssenweg 150  
5026 RH Tilburg, Netherlands

**Phone:** +31 (0)13 - 45 87 130 (Europe)  
**E-mail:** infointl@nonin.com

www.nonin.com

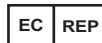

MPS, Medical Product Service GmbH  
Borngasse 20  
D-35619 Braunfels, Germany



MedEnvoy Switzerland  
Gotthardstrasse 28  
6302 Zug, Switzerland

References to “Nonin” in this manual shall imply Nonin Medical, Inc.

Nonin, PalmSAT, PureLight and nVISION are registered trademarks or trademarks of Nonin Medical, Inc.

Microsoft® and Windows® are registered trademarks of Microsoft Corporation.

© 2024 Nonin Medical, Inc.

**7923-101-07 08/2024**

# Contents

<b>Indications for Use / Intended Use / Intended Purpose .....</b>	<b>1</b>
Clinical Benefits .....	1
Warnings .....	1
Cautions .....	2
<b>Guide to Symbols .....</b>	<b>5</b>
<b>Displays and Indicators .....</b>	<b>7</b>
SpO <sub>2</sub> Display .....	7
Pulse Rate Display .....	7
Pulse Quality Display.....	7
Low Battery Indicator.....	7
Sensor Fault Display .....	8
Alarm Bar.....	8
Alarm Silence Indicator.....	8
Pulse Rate Tone.....	8
<b>Using the PalmSAT Pulse Oximeter .....</b>	<b>9</b>
Unpacking the Model 2500A .....	10
Installing and Using the Batteries .....	11
Important Notes about Battery Use .....	12
With AA Batteries.....	12
With Rechargeable NiMH Battery Pack .....	12
Recharging Batteries (NiMH Battery Pack only).....	13
Connecting the Sensor.....	13
Power On/Off.....	13
Power On Self-Test .....	13
Monitoring.....	14
<b>Detailed Operation.....</b>	<b>15</b>
Setup Mode .....	15
Entering Setup Mode .....	15
Making Selections in Setup Mode.....	15
<b>Care and Maintenance.....</b>	<b>17</b>
<b>Alarm Functions .....</b>	<b>18</b>
High and Medium Priority Alarms .....	18
Adjusting Alarm Settings .....	19
Recalling Previous Alarm Settings .....	19
Reviewing Alarm Settings.....	20
Silencing Audible Alarms.....	20
System Fault Alarms .....	20
<b>Memory Functions.....</b>	<b>21</b>
Memory Playback.....	21

## Contents (Continued)

Playing Back the Data Stored in Memory .....	21
Clearing the Memory .....	22
Choosing Memory Clear Settings .....	22
Choosing Calendar and Clock Settings .....	22
<b>Communications .....</b>	<b>23</b>
Serial Output .....	23
Connecting the Device into a Medical System .....	23
<b>Service, Support and Warranty .....</b>	<b>25</b>
Warranty .....	25
<b>Parts and Accessories .....</b>	<b>26</b>
<b>Troubleshooting .....</b>	<b>27</b>
<b>Technical Information .....</b>	<b>30</b>
Manufacturer's Declaration .....	30
Essential Performance .....	30
Equipment Response Time .....	32
Testing Summary .....	33
SpO <sub>2</sub> Accuracy Testing .....	33
Pulse Rate Motion Testing .....	33
Low Perfusion Testing .....	33
Principles of Operation .....	33
Specifications .....	34

## Figures

Figure 1. Displays, Indicators and Buttons.....	9
Figure 2. Rear View.....	10
Figure 3. Installing Batteries.....	12
Figure 4. Connecting a Sensor.....	13

## Tables

Table 1. Labeling Symbols.....	5
Table 2. Adjustable Parameters and Settings.....	16
Table 3. High and Medium Priority Alarms .....	18
Table 4. Alarm Limits .....	19
Table 5. Pulse Oximeter Sensor Connector Pin Assignments.....	23
Table 6. Electromagnetic Emissions.....	30
Table 7. Electromagnetic Immunity.....	31
Table 8. Not Applicable.....	31



## Indications for Use / Intended Use / Intended Purpose

The Nonin® Model 2500A PalmSAT® Pulse Oximeter with Alarms is indicated for use in measuring and displaying functional oxygen saturation of arterial hemoglobin (SpO<sub>2</sub>) and pulse rate for adult, pediatric, and neonatal patients. The device is intended for continuous monitoring and/or spot-checking of patients during both motion and no-motion conditions, and for patients who are well or poorly perfused.

### Clinical Benefits

Nonin pulse oximeters allow for the management of patients' medical conditions by providing fast, accurate, real-time, noninvasive oxygen measurement in order to meet patients' medical needs.

### Warnings

Do not use this device in an MR environment.
<b>Explosion Hazard:</b> Do not use in an explosive atmosphere or in the presence of flammable anesthetics or gasses.
This device is not defibrillation proof per IEC 60601-1.
This device is intended only as an adjunct in patient assessment. It must be used in conjunction with other methods of assessing clinical signs and symptoms.
Oximeter readings of this device may be affected by the use of an electrosurgical unit (ESU).
Inspect the sensor application site at least every 6 to 8 hours to ensure correct sensor alignment and skin integrity. Patient sensitivity to sensors and/or double-backed adhesive strips may vary due to medical status or skin condition.
To avoid patient injury, use only with Nonin-branded PureLight® pulse oximeter sensors. These sensors are manufactured to meet the accuracy specifications for Nonin Pulse Oximeters. Using other manufacturers' sensors can result in improper pulse oximeter performance.
To prevent improper performance and/or patient injury, verify compatibility of the monitor, sensor(s), and accessories before use.
No modifications to this device are allowed as it may affect device performance.
Do not use a damaged sensor. If the sensor is damaged in any way, discontinue use immediately and replace the sensor.
Verify all alarm settings and limits during system startup to ensure that they are set as intended.
A hazard can exist if different presets are used on multiple 2500A monitors in one care area.
As with all medical equipment, carefully route patient cabling to reduce the possibility of patient entanglement, strangulation, or injury to the patient.
This device should not be used adjacent to or stacked with other equipment. If adjacent or stacked use is necessary, the device should be observed carefully to verify normal operation.

## Warnings (Continued)

The use of accessories, sensors, cables, and power supplies other than those specified in the Parts and Accessories List may result in increased electromagnetic emission and/or decreased immunity of this device.
This device must be able to measure the pulse properly to obtain an accurate SpO <sub>2</sub> measurement. Verify that nothing is hindering the pulse measurement before relying on the SpO <sub>2</sub> measurement.
Operation of this device below the minimum amplitude of 0.3% modulation may cause inaccurate results.
Discontinue use of adhesive tape strips if the patient exhibits an allergic reaction to the adhesive material.
Avoid excessive pressure to the sensor application site as this may cause damage to the skin beneath the sensor.
Because operating environments vary, use caution to ensure that all audible alarms and indicators can be heard. Users must determine the acceptable audible distance of all alarms.
Do not place this device in an environment where its speaker opening may become blocked; alarms may become muffled or inaudible.
Turning off the alarm volume creates a situation that is not compliant with relevant safety standards. The alarm silence indicator is lit solid when the alarm volume is turned off or set below 45 dBA.
When a system fault occurs, the patient will no longer be monitored.
To comply with relevant product safety standards, ensure that all alarm volumes are set appropriately and are audible in all situations. Do not cover or otherwise hinder any speaker openings.
The device turns off after approximately 10 minutes when at low battery capacity.
Before changing the batteries, make sure the device is off and the sensor is not attached to a digit.
Portable RF communications equipment such as cell phones or radios (including peripherals such as antenna cables and external antennas) should be used no closer than 30 cm (12 inches) to any part of the ME system, including cables specified by the manufacturer. Otherwise, degradation of the performance of this equipment could result.

## Cautions

Before use, carefully read the package insert provided with the sensors.
This device is not an apnea monitor.
Verify that all visible indicators illuminate and that an audible indicator sounds during the startup (initialization) sequence. If any indicator is not lit or the audible indicator does not sound, do not use the device. Contact Nonin Technical Service for assistance.
Review all limits to ensure they are appropriate for the patient.
Setting alarm limits to extremes can render the alarm system useless.
The presence of a defibrillator may interfere with the performance of this device.
This device may not work on all patients. If you are unable to achieve stable readings, discontinue use.



## Cautions (Continued)

<p>This device has motion tolerant software that minimizes the likelihood of motion artifact being misinterpreted as good pulse quality. In some circumstances, however, the device may still interpret motion as good pulse quality. Minimize patient motion as much as possible.</p>
<p>Ear Clip and Reflectance sensors are not recommended for pediatric or neonatal use. The accuracy of these sensors has not been established for pediatric or neonatal use.</p>
<p>Do not autoclave or immerse the device or sensors in liquid. Do not expose the device or components to excessive moisture or liquids.</p>
<p>Do not use caustic or abrasive cleaning agents on the device or the sensors.</p>
<p>The oximeter sensor might not work on cold extremities due to reduced circulation. Warm or rub the finger to increase circulation, or reposition the sensor.</p>
<p>Replace the batteries as soon as possible after a low-battery indication. Always replace the batteries with fully charged batteries.</p>
<p>Use only Nonin-specified battery types with this device.</p>
<p>Do not use fully charged and partially charged batteries at the same time. This may cause the batteries to leak.</p>
<p>Do not remove any covers other than the battery cover when replacing batteries. There are no user-serviceable parts inside other than the replaceable batteries.</p>
<p>Follow local, state and national governing ordinances and recycling instructions regarding disposal or recycling of the device and device components, including batteries.</p>
<p>Batteries may leak or explode if used or disposed of improperly.</p>
<p>Remove the batteries if the device will be stored for more than 1 month.</p>
<p>This equipment complies with IEC 60601-1-2 for electromagnetic compatibility for medical electrical equipment and/or systems. This standard is designed to provide reasonable protection against harmful interference in a typical medical installation. However, because of the proliferation of radio-frequency transmitting equipment and other sources of electrical noise in healthcare and other environments, it is possible that high levels of such interference due to close proximity or strength of a source might disrupt the performance of this device. Medical electrical equipment needs special precautions regarding EMC, and all equipment must be installed and put into service according to the EMC information specified.</p>
<p>In compliance with the European Directive on Waste Electrical and Electronic Equipment (WEEE) 2002/96/EC, do not dispose of this product as unsorted municipal waste. This device contains WEEE materials; please contact your distributor regarding take-back or recycling of the device. If you are unsure how to reach your distributor, please call Nonin for your distributor's contact information.</p>
<p>This device's display will go blank after 10 seconds of inadequate signals. The data update period is every 1.5 seconds.</p>

## ***Cautions (Continued)***

This device is designed to determine the percentage of arterial oxygen saturation of functional hemoglobin. Factors that may degrade pulse oximeter performance or affect the accuracy of the measurement include the following:

- excessive ambient light
- excessive motion
- electro-surgical interference
- blood flow restrictors (arterial catheters, blood pressure cuffs, infusion lines, etc.)
- moisture in the sensor
- improperly applied sensor
- incorrect sensor type
- inadequate signal
- venous pulsations
- anemia or low hemoglobin concentrations
- cardiogreen and other intravascular dyes
- carboxyhemoglobin
- methemoglobin
- dysfunctional hemoglobin
- artificial nails or fingernail polish
- a sensor not at heart level.

A functional tester cannot be used to assess the accuracy of a pulse oximeter monitor or sensor.

All parts and accessories connected to the serial port of this device must be certified according to at least IEC 60950 or UL1950 for data-processing equipment.

This device is a precision electronic instrument and must be repaired by trained Nonin personnel only. Field repair of the device is not possible. Do not attempt to open the case or repair the electronics. Opening the case may damage the device and void the warranty.

Any sign or evidence of opening the system, field service by non-Nonin personnel, tampering, or any kind of misuse or abuse of the system, shall void the warranty in its entirety.

Replace batteries within 30 seconds to avoid losing settings (date, time, and patient data stored in memory) or corrupting data.













Radios and cell phones or similar devices can affect the equipment and must be kept at least 2 meters (6.5 feet) away from equipment.

Failure of a network data coupling (serial cable/connectors/wireless connections) will result in loss of data transfer.















## Guide to Symbols

This table describes the symbols that are found on the Model 2500A and in this manual.

**Table 1: Labeling Symbols**

Symbol	Description
	CAUTION
	Consult Instructions for Use.
	Follow Instructions for Use.
	Medical Device
	Type BF Applied Part (Patient isolation from electrical shock).
	UL Mark for Canada and the United States with respect to electric shock, fire, and mechanical hazards only in accordance with UL 60601-1 and CAN/CSA-C22.2 No. 601.1.
CE0123	CE Marking indicating conformance to EC directive No. 93/42/EEC concerning medical devices.
	MR Unsafe
SN	Serial Number (located under the back cover).
IP32	Protected against vertically falling water drops when enclosure is tilted up to 15 degrees and ingress of solid foreign objects greater than or equal to 2.5 mm (0.1 in.) in diameter per IEC 60529.
	Indicates separate collection for electrical and electronic equipment (WEEE).
	Authorized Representative in the European Community.
	Authorized Representative in Switzerland
	Manufacturer
	Date of Manufacture
	Country of Manufacturing
%SpO <sub>2</sub>	%SpO <sub>2</sub> Display

**Table 1: Labeling Symbols**

Symbol	Description
	Pulse Rate Display
	Pulse Quality Display
	Low Battery LED
	Alarm Silence LED
	Unique Device Identifier
	Importer
	Distributor
	Keep Dry
	Handle With Care
	Humidity Limitation
	Use by
	Do Not Reuse
<b>Front Panel Buttons</b>	
	On/Off
	Advance

## Displays and Indicators

### *SpO<sub>2</sub> Display*

The SpO<sub>2</sub> display is the upper numeric display (identified by the %SpO<sub>2</sub> symbol). This 3-digit light-emitting diode (LED) display shows the current oxygen saturation percentage. This display flashes for SpO<sub>2</sub> alarms.

### *Pulse Rate Display*

The Pulse Rate display is the lower numeric display (identified by the  symbol). This 3-digit LED display shows the pulse rate in pulses per minute. This display flashes for Pulse Rate alarms.

### *Pulse Quality Display*

The Pulse Quality display (identified by the  symbol) is a tricolor LED that blinks once for each detected pulse. The Pulse Quality display changes color to indicate changes in the pulse waveform signal that may affect the SpO<sub>2</sub> data. It may blink green, amber or red.

- **Green** indicates a good pulse strength
- **Amber** indicates a marginal pulse strength. To improve signal quality, reposition the sensor, try a different sensor type, eliminate patient movement, or improve the site's circulation.
- **Red** indicates an inadequate pulse strength. While the Pulse Quality display is red, SpO<sub>2</sub> and pulse rate values are not updated. After about 10 seconds, the values are replaced with dashes, indicating that readings are not possible.

### *Low Battery Indicator*

Low and critically low battery capacity is indicated with a flashing Low Battery indicator and a medium priority alarm. When batteries are critically low, the digital displays will go blank, and the Pulse Quality display will blink amber or red, but not green. Any SpO<sub>2</sub> or pulse rate alarms in effect when critically low battery capacity is reached will be latched, and flashing dashes will appear on the corresponding display. After 10 minutes at critically low battery capacity, the pulse oximeter will shut off automatically.

## ***Sensor Fault Display***

If the device determines that a sensor fault exists (a sensor disconnect, failure, misalignment or incompatibility with the monitor) or if a pulse oximeter sensor signal is no longer detected, a dash (-) appears in the left-most digit of the SpO<sub>2</sub> display. The readings that are displayed will freeze for 10 seconds if the pulse oximeter sensor fault or the inadequate signal continues. A sensor fault is a medium priority alarm.

If the sensor fault or the inadequate signal is not corrected, the frozen readings and the left-most dash will be replaced by dashes in the middle digit of both the SpO<sub>2</sub> and the Pulse Rate displays, 10 seconds after the first dash appeared.

When the sensor fault or the inadequate signal is corrected, the SpO<sub>2</sub> and pulse rate displays will return to normal operation.

## ***Alarm Bar***

The Alarm Bar flashes amber or red, indicating medium or high priority alarms, respectively. This indicator is located near the top of the device.

## ***Alarm Silence Indicator***

The Alarm Silence indicator (identified by the  symbol) is located to the left of the On/Off button. Whenever the Alarm Silence indicator is flashing, all audible alarms are temporarily silenced. If the alarm volume is set to "off," the Alarm Silence indicator is lit solidly.

## ***Pulse Rate Tone***

When the Pulse Rate tone is active, a beep sounds for each detected pulse. This beep changes in pitch with SpO<sub>2</sub> values. The default volume is OFF. During normal operation, the volume can be changed (off, low, or high) by momentarily pressing the advance button.

## Using the PalmSAT Pulse Oximeter

The Model 2500A PalmSAT is a digital handheld pulse oximeter that displays numerical values for blood oxygen saturation (%SpO<sub>2</sub>) and pulse rate. It provides audible and visual alarms for both medium and high priority conditions.

This device will typically operate for 60 hours continuously between alkaline battery replacements, or for 40 hours with the Model 2500B Rechargeable NiMH (Nickel Metal Hydride) Battery Pack (optional). The device requires no routine calibration or maintenance other than replacement of alkaline batteries or recharging the optional battery pack with the Model 2500C Charger Stand (refer to the Model 2500C Operator's Manual).

The pulse oximeter determines functional oxygen saturation of arterial hemoglobin (SpO<sub>2</sub>) by measuring the absorption of red and infrared light passing through perfused tissue. Changes in absorption caused by the pulsation of blood in the vascular bed are used to determine oxygen saturation and pulse rate.

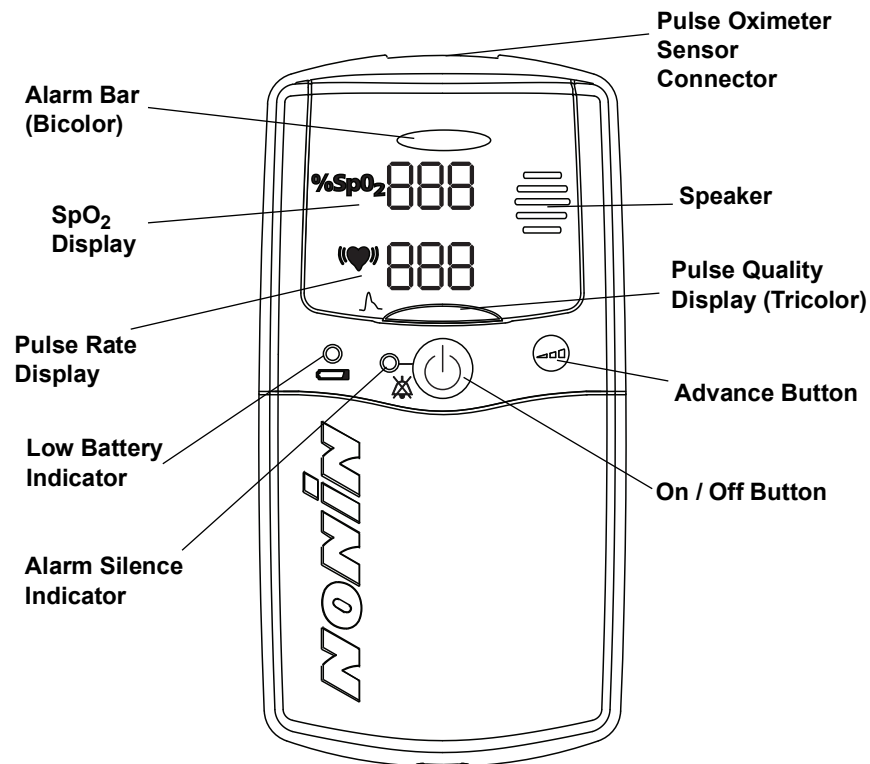

**Figure 1: Displays, Indicators and Buttons**

Oxygen saturation and pulse rate values are displayed by light-emitting diode (LED) digital displays. On each detected pulse, the Pulse Quality display blinks. Patient pulse quality signals are graded as good, marginal, or inadequate and are indicated as such by the Pulse Quality display blinking green, amber or red, respectively. This simple method gives the user a pulse-by-pulse visual indication of waveform signal quality without requiring the user to perform complex waveform analysis.

The Model 2500A Pulse Oximeter may be used with a variety of Nonin-branded PureLight pulse oximeter sensors.

A sensor disconnect or malfunction is indicated by an inadequate Pulse Quality display blinking and/or a dash to the left of the SpO<sub>2</sub> value on the LED display. When adequate pulse signals are not received, the SpO<sub>2</sub> and/or pulse rate numerical values will be replaced by dashes. Low and critically low battery conditions will be indicated by the Low Battery indicator.

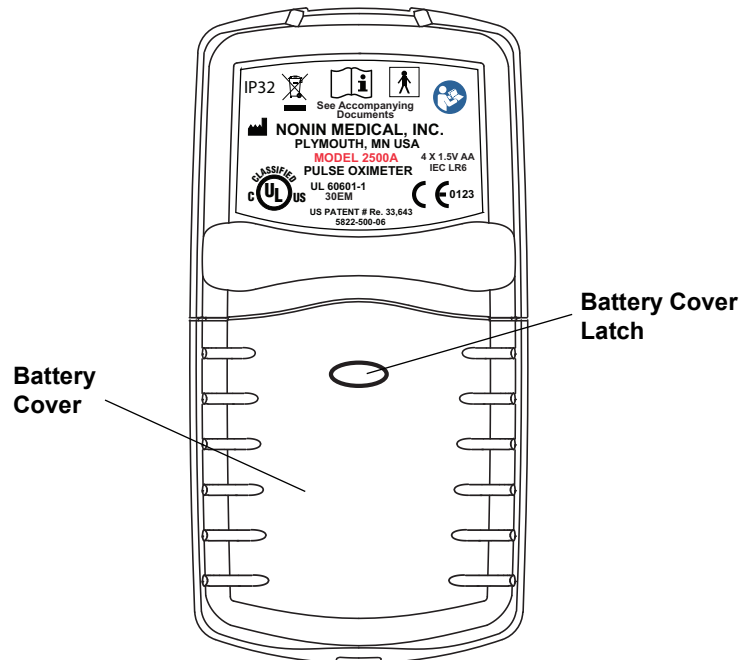

Figure 2: Rear View

## Unpacking the Model 2500A

The Model 2500A complete system includes the following items:

- 1 Model 2500A Pulse Oximeter
- 1 Model 2500A Instructions for Use
- 1 Nonin Pulse Oximeter Sensor
- 4 AA-Size Alkaline Batteries

Confirm that the items listed are packed with the system. If any item on this list is missing or damaged, contact your distributor. Contact the carrier immediately if the shipping carton is damaged.



## Installing and Using the Batteries

The Model 2500A can be powered by 4 AA-size alkaline batteries, or by the optional Rechargeable NiMH Battery Pack, Model 2500B.



**CAUTION:** Use only Nonin-specified battery types with this device.

Low and critically low battery capacity is indicated with a flashing Low Battery indicator and a medium priority alarm. When batteries are critically low, the digital displays will go blank, and the Pulse Quality indicator will blink amber or red, but not green. Any SpO<sub>2</sub> or pulse rate alarms in effect when critically low battery capacity is reached will be latched, and flashing dashes will appear on the corresponding display. After 10 minutes at critically low battery capacity, the pulse oximeter will shut off automatically.

**WARNING:** The device turns off after approximately 10 minutes when at critically low battery capacity.

**WARNING:** Before changing the batteries, make sure the device is off and the sensor is not applied to a digit.



**CAUTION:** Replace the batteries as soon as possible after a low-battery indication. Always replace the batteries with fully charged batteries.

1. Press the battery cover latch, and remove the battery cover on the bottom of the unit.
2. Insert four new AA-size alkaline batteries or a Rechargeable NiMH Battery Pack. Be sure to insert the batteries in the correct position, as indicated by the polarity markings (+ and -) inside the battery compartment. *Proper battery positioning is essential for correct operation.*
3. Replace the battery cover and turn on the device. If the unit does not turn on, see “Troubleshooting.”



**CAUTION:** Replace batteries within 30 seconds to avoid losing settings (date, time, and patient date stored in memory) or corrupting data.

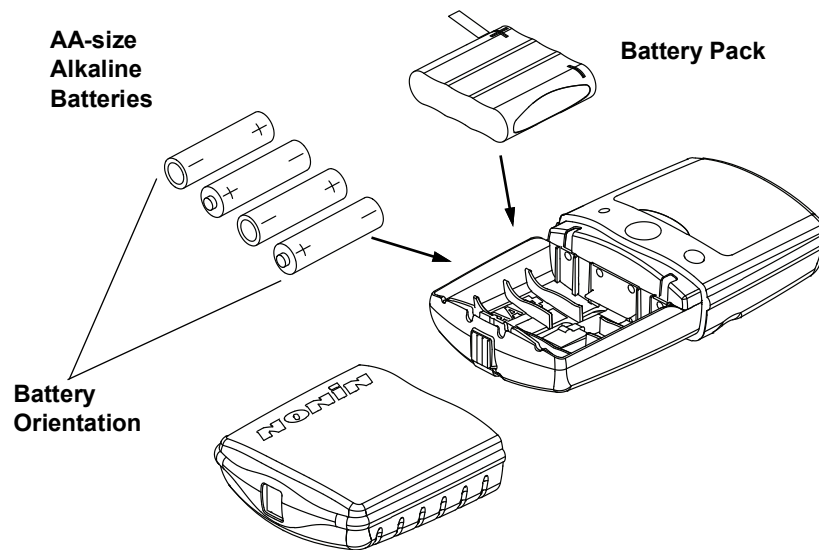

**Figure 3: Installing Batteries**

## ***Important Notes about Battery Use***

Four AA alkaline batteries provide the device with approximately 60 hours of continuous operation, while the Rechargeable NiMH Battery Pack provides approximately 40 hours of continuous operation.

**Clock/calendar settings can significantly affect battery storage life.** Batteries drain during storage, but they drain much more quickly when the unit's clock/calendar functions are set. Refer to "Clock and Calendar Settings" for more information.

### **With AA Batteries**

- If the clock/calendar is *not* set when the unit is stored, alkaline batteries will need replacement in 10-12 months *if the unit has not been used*.
- If the clock/calendar *is* set when the unit is stored and *if the unit has not been used*, alkaline batteries will require replacement in about 6 weeks.
- Using the oximeter will shorten the required replacement time.

### **With Rechargeable NiMH Battery Pack**

- If the clock/calendar is *not* set when the unit is stored, and *if the unit has not been used*, the Rechargeable NiMH Battery Pack will need recharging at least every 2 months.
- If the clock/calendar *is* set when the unit is stored, and *if the unit has not been used*, the Rechargeable NiMH Battery Pack will need recharging at least every 3 weeks.
- Using the oximeter will shorten the required recharging time.

## Recharging Batteries (NiMH Battery Pack only)

- Completely recharging the NiMH battery pack requires approximately 180 minutes when the unit is completely discharged.
- The expected useful life of the Rechargeable NiMH battery pack is 500 charge/discharge cycles, or approximately 10 years, whichever is first. The battery pack must be charged at least once each year to maintain optimal battery life.
- AA alkaline batteries cannot be recharged in the charging stand.

## Connecting the Sensor

Connect the pulse oximeter sensor (with the Nonin logo facing up) to the top of the device as shown. Ensure that the sensor is firmly plugged in. Refer to “Specifications” or to the specific sensor package insert for pulse oximeter sensor positioning information.

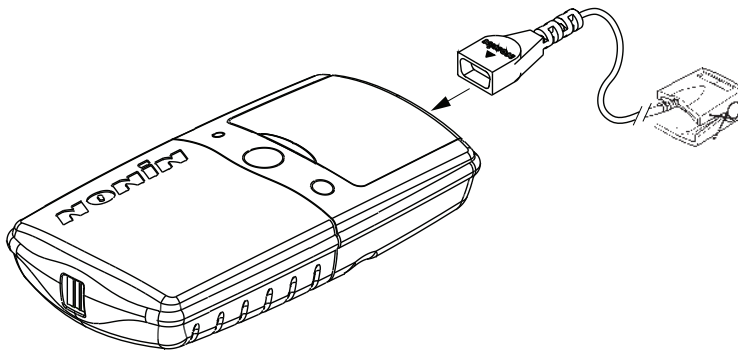

Figure 4: Connecting a Sensor

## Power On/Off

- **Turn on** the device by pressing and releasing the On/Off button on the front of the unit.
- **Turn off** the device by pressing and holding the On/Off button for approximately 2 seconds.

To conserve battery life, the device automatically powers off after 10 minutes of inactivity. Inactivity is indicated by dashes on the displays and may result from an improperly connected or positioned sensor, or from an inadequate patient pulse signal.

## Power On Self-Test

When the Model 2500A is turned on for normal operation, the unit will cycle through a startup/initialization sequence before displaying valid data. During startup, always check for any missing indicators or LED display segments and ensure that the audible indicator sounds. If any indicator is not functioning, do not use the device. Contact Nonin Technical Service for repair or replacement.

During its normal startup sequence, the device will cycle as follows:

- “888 888” appears briefly in the SpO<sub>2</sub> and Pulse Rate displays.
- the amber Low Battery and Alarm Silence indicators turn on steadily for a few seconds.

- the Pulse Quality display turns red for 1 second, then green for 1 second, then shuts off, while the Alarm Bar turns red for 1 second, then amber for 1 second.
- the clock time currently set in the memory (in hours and minutes, 04 41 for example) appears briefly in the displays.
- the software revision numbers (display in the following order, each for approximately 1 second): Main revision “r” + 3 digits; Memory revision “n” “n” (for m) + 3 digits; Sound revision “s” + 3 digits.
- three audible beeps sound.
- **==** (two dashes) appear in the displays until a valid pulse signal is detected.

---

**NOTES:**

- The two-minute alarm silence feature is automatically enabled immediately after the startup sequence.
  - This startup sequence varies slightly when entering setup mode at power on.
- 

## ***Monitoring***



Verify that the pulse oximeter sensor is properly positioned on the patient. Ensure that the pulse oximeter is sensing adequate pulse quality by:

- verifying that the Pulse Quality display is blinking green *and*
- verifying that the Pulse Rate and SpO<sub>2</sub> displays are displaying readings *and*
- verifying that blinking of the Pulse Quality display is in time with the pulse rate for at least 10 seconds

If the Pulse Quality display is blinking red or amber or is blinking erratically, reposition the sensor or replace the sensor.

If the sensor is not properly positioned, or no sensor is attached to the pulse oximeter after startup (a few seconds after powering on), both the SpO<sub>2</sub> and Pulse Rate displays will display a single dash until a valid pulse signal is detected.

## Detailed Operation

All functions of the Model 2500A are controlled by the **On/Off**  and **Advance**  buttons located on the front of the unit.

### Setup Mode

Setup mode is used to adjust alarm, memory clear, and memory playback functions, as well as to set the calendar and clock. In Setup mode, the **Advance** and **On/Off** buttons are used to make all selections.

---

**NOTE:** Setting the month to “00” disables the calendar and clock functions and helps conserve battery life.

---

### Entering Setup Mode

1. With the unit off, press and hold the **Advance** button while pressing and then releasing the **On/Off** button.
2. Release the advance button when 888 888 is displayed on the SpO<sub>2</sub> and Pulse Rate displays. The clock time currently set in the memory, 04 41 for example, appears briefly in the displays, and then rCL no appears.

### Making Selections in Setup Mode

**WARNING:** Verify all alarm settings and limits during system startup to ensure that they are set as intended.



**CAUTION:** Review all limits to ensure they are appropriate for the patient.



**CAUTION:** Setting alarm limits to extremes can render the alarm system useless.

1. When entering Setup mode, rCL no is displayed. (This indicates that Recall Alarms is the setting being adjusted, and that the default value is “no.” See Table 2.) Press and release the **Advance** button to change the value for this setting (or press and hold the Advance button to scroll quickly through the range of adjustable values).
2. When the desired value appears, press and release the **On/Off** button to store the value and advance to the next adjustable parameter, as listed in the following table.
3. Continue this process until all settings are chosen.

When the setting sequence is complete, the device exits Setup mode, automatically displays the alarm settings in effect, and is then ready to begin normal operation.

**Table 2: Adjustable Parameters and Settings**

Setting	Appears in SpO <sub>2</sub> Display	Range of Values Appears in Pulse Rate Display	Default Value
Recall Alarm Settings <sup>1</sup>	rCL	yES or no	no
SpO <sub>2</sub> Low Alarm	02L	50 - 95, OFF	85
Heart Rate High Alarm	H H	75 - 275, OFF	200
Heart Rate Low Alarm	H L	30 - 110, OFF	50
SpO <sub>2</sub> High Alarm	02H	80 - 100, OFF	OFF
Audible Alarms	Adb	Hi, Lo, OFF	Hi
Memory Clear <sup>2</sup>	CLr	yES or no	no
Delete (confirm clear)	dEL	yES or no	no
Year	y	00 - 99	07
Month	nn	00 - 12	00
Day	d	01 - 31	00
Hour	h	00 - 23	00
Minute	nn	00 - 59	00
<b>Notes:</b> 1) Choosing “yes” for rCL (Recall Alarm Settings) will recall previous alarm settings and exit setup mode. 2) Choosing “yes” for both the CLr and dEL settings (the memory clear function) will clear the memory and exit setup mode.			

## Care and Maintenance

Clean the device separately from the sensors. For instructions on cleaning pulse oximeter sensors, refer to the respective sensor instructions for use.

The Oxitest<sup>Plus7</sup> by Datrend Systems, Inc. can be used to verify operation of the pulse oximeter.



**CAUTION:** Do not autoclave or immerse the device or sensors in liquid. Do not expose the device or components to excessive moisture or liquids.



**CAUTION:** Do not use caustic or abrasive cleaning agents on the device or the sensors.

Clean the device with a soft cloth dampened with isopropyl alcohol. Do not pour or spray any liquids onto the device, and do not allow any liquid to enter any openings in the device. Allow the device to dry thoroughly before reusing.

## Alarm Functions

This section describes the alarm functions of the Model 2500A.

The intended operator's position for correctly perceiving a visual alarm signal and its priority is 1 meter (3.3 feet).

### ***High and Medium Priority Alarms***

The Model 2500A features audible and visual alarms that indicate both high and medium priority alarm conditions. In general, high priority alarms are patient-specific and are indicated by a flashing red alarm bar and a high priority audible alarm signal. High priority alarms are sounded as follows: three beeps, a pause, and two beeps followed by an approximate 10-second pause. This cycle repeats until silenced.

Medium priority alarms are generally equipment-specific, and are indicated by a flashing amber alarm bar and a medium priority audible alarm signal. Medium priority alarms are sounded as follows: three beeps, an approximate 25-second pause and three beeps.

The following table describes alarm conditions, visible indication, and priorities.

**WARNING: When a system fault occurs, the patient will no longer be monitored.**

**Table 3: High and Medium Priority Alarms**

Condition	Visible Indication	Alarm Priority
SpO <sub>2</sub> high or low	The SpO <sub>2</sub> display flashes in sync with the Alarm Bar. If in battery critical state, three dashes are inserted in the display and flash in sync with the Alarm Bar.	High
Pulse Rate high or low	The pulse display flashes in sync with the Alarm Bar. If in battery critical state, three dashes are inserted in the display and flash in sync with the Alarm Bar.	High
Pulse Wave form amplitude is inadequate	Pulse Quality LED blinks red, SpO <sub>2</sub> and heart rate LED go to dashes in 10 sec.	High
Inadequate Signal (i.e., sensor dislodgement, unusable signal)	Pulse Quality LED blinks. Display "dash" sign in leftmost SpO <sub>2</sub> LED, freeze both numeric displays for 10 seconds, display "dash" sign in middle LED of SpO <sub>2</sub> and pulse rate numeric displays.	Medium
Sensor fault I (i.e., sensor disconnect, bad cable, Nonin incompatible sensor)	Pulse Quality LED is blank. Display "dash" sign in leftmost SpO <sub>2</sub> LED, freeze both numeric displays for 10 seconds, display "dash" sign in middle LED of SpO <sub>2</sub> and pulse rate numeric displays.	Medium
SpO <sub>2</sub> or pulse rate data not adequate for more than 20 seconds	Display "dash" sign in middle LED of SpO <sub>2</sub> and pulse rate numeric displays (i.e. out-of-track indication).	Medium



**Table 3: High and Medium Priority Alarms (Continued)**

Condition	Visible Indication	Alarm Priority
Pulse rate date not updated for more than 30 seconds	Pulse rate numeric display goes to dashes.	Medium
Battery marginal	Battery low indicator flashing (2500A). No other displays are affected.	Medium
Battery critical	Battery low indicator flashing, blank all SpO <sub>2</sub> and pulse rate numeric LEDs, latch pulse quality at red or yellow, but not green.	Medium
Sound Module or system failure detected	Display error code.	Medium

## Adjusting Alarm Settings

**WARNING: To comply with relevant product safety standards, ensure that all alarm volumes are set appropriately and are audible in all situations. Do not cover or otherwise hinder any speaker openings.**

Users may adjust the alarm limits for upper and lower SpO<sub>2</sub> and Pulse Rate alarms and alarm volume as shown below.

**Table 4: Alarm Limits**

Alarm Limit	Default	Adjustment Options	Increments
SpO <sub>2</sub> High	Off	Off, 80–100	1%
SpO <sub>2</sub> Low	85%	Off, 50–95	1%
Pulse Rate High	200 BPM	Off, 75–275	5 BPM
Pulse Rate Low	50 BPM	Off, 30–110	5 BPM
Alarm Volume	Hi	Off, Lo, Hi	N/A

Adjusting alarm settings is only possible when the device is in Setup mode. For every power on in which alarm settings have not been recalled or adjusted in Setup mode, the default alarm settings remain in effect.

## Recalling Previous Alarm Settings

The most recently adjusted alarm limits and volume may be recalled each time the device is started up. These alarm settings are retained and available for recall for approximately 30 seconds after batteries are removed.



**CAUTION:** Replace batteries within 30 seconds to avoid losing settings (date, time, and patient date stored in memory) or corrupting data.

**NOTE:** The SpO<sub>2</sub> Low Alarm setting will default to 85% if set below 85%, and anytime the unit is powered off.

1. With the unit off, press and hold the **Advance** button while pressing and then releasing the **On/Off** button.  
This enters Setup mode and displays rCL no—indicating that Recall Alarms is the parameter being adjusted, and that the default value is “no.”
2. Press and release the **Advance** button.  
This changes the Recall Alarms value to yES—indicating that previously-adjusted alarm settings will be recalled.
3. Press and release the **On/Off** button to select yES and recall all previously-adjusted alarm and volume settings.

All recalled settings are individually flashed on the display screen before the unit begins normal operation.

**NOTE:** Setup mode exits automatically after Recall Alarms setting is selected.

## ***Reviewing Alarm Settings***

At any time during normal operation, alarm limits and volume settings can be reviewed by pressing and holding the **Advance** button for one second. All settings are then individually flashed on the display screen.

**NOTE:** To stop the alarm review early and return to normal operation, press the Advance button momentarily.

## ***Silencing Audible Alarms***

Audible alarms are automatically silenced for the first 2 minutes of normal operation. Momentarily press the **On/Off** button to temporarily silence audible alarms (2 minute silence) during normal operation. Press the **On/Off** button again to cancel the temporary alarm silence.

## ***System Fault Alarms***

If the device determines that a system fault exists, an error message (e.g., Err E01) appears in the SpO<sub>2</sub> and Pulse Rate displays, along with medium priority alarm indicators. A system fault has also occurred if the displays and indicators are blank but a continuous audible alarm is sounding. Attempt to clear the error by turning the device off and on. If the problem persists, contact Nonin Technical Service.

**WARNING:** When a system fault occurs, the patient will no longer be monitored.

## Memory Functions

Each time the Model 2500A is turned on (except during Setup mode), data are automatically collected in memory. The device can collect and store up to 72 hours of SpO<sub>2</sub> and pulse rate information.

---

**NOTE:** Only recording sessions longer than 1 minute are stored in memory. Memory will clear approximately 30 seconds after removing the batteries. Replace batteries immediately to avoid losing stored data.

---

Nonin's nVISION data management software is available for use with Microsoft Windows operating systems.

The memory in the device functions as an "endless loop." When the memory fills up, the unit begins overwriting the oldest data with the newest.

Each time the device is turned on, the current time/date information (if the clock is set correctly) is stored in memory to allow quick differentiation of recording sessions. Patient SpO<sub>2</sub> and pulse rate are sampled and stored every 4 seconds.

Oxygen saturation values are stored in 1% increments in the range of 0 to 100%.

The stored pulse rate ranges from 18 to 300 pulses per minute. The stored values are in increments of 1 pulse per minute in the interval from 18 to 200 pulses per minute, and increments of 2 pulses per minute in the interval from 201 to 300 pulses per minute.

During the printing of the data, the last data recorded are the first data printed. For example, the last 4 minutes of data recorded would be the first 4 minutes of printout.



## Memory Playback

---

**NOTE:** Playing back the data in memory does not clear the data from memory.

---

### Playing Back the Data Stored in Memory

1. With the unit off, press and hold the **Advance** button  while pressing and then releasing the **On/Off** button .
2. Release the advance button when 888 888 is displayed on the SpO<sub>2</sub> and pulse rate displays. The clock time currently set in the memory (04 41 for example) appears briefly in the displays, and then rCL no appears.
3. Data will be automatically played back from the memory. Data are played back at a rate of 20 minutes of collected data per second. A 72-hour recording session (the maximum memory saved) is played back in approximately 3.5 minutes.
4. After all data are played back, the device should be shut off before collecting new patient data. The patient information is held in memory as long as the batteries are sufficiently charged, so if the memory must be cleared, use the memory clear function.

## Clearing the Memory

The Memory Clear function allows you to delete all data currently stored in memory.

### Choosing Memory Clear Settings

1. Enter Setup mode, and scroll through the settings until CLr is displayed.
2. CLr may be set to no or yES.
  - If no is entered in response to CLr (indicating that you do not want to clear the memory), the setup mode will continue directly to the calendar and clock settings. (Refer to “Clock and Calendar Settings.”)
  - If yES is entered in response to CLr, then dEL will next appear in the SpO<sub>2</sub> display, again with a choice of no or yES. This prompting gives you a second opportunity to avoid clearing the memory.

Make the CLr selection. Use the Advance button to scroll through the values. Use the On/Off button to accept a value and move to the next setting.

3. dEL may be set to no or yES.
  - If no is entered in response to dEL (indicating that you do not want to clear the memory), the setup mode will continue directly to the calendar and clock settings. (Refer to “Choosing Calendar and Clock Settings.”)
  - If yES is entered in response to dEL, (confirming that you do want to clear the memory), then dnE CLr will briefly appear in the displays indicating that the memory is cleared. After the alarm settings are reviewed, the device will exit setup mode and is ready to begin normal operation.

Make the dEL selection. Use the Advance button to scroll through the values. Use the On/Off button to accept a value and move to the next setting.

### Choosing Calendar and Clock Settings

---

**NOTE:** Setting the month to “00” disables the calendar and clock functions and helps conserve battery life.

---

1. After selecting no in the memory clear settings, y will appear in the SpO<sub>2</sub> display indicating the calendar year setting.
2. Make the year, month, day, hour, and minute selections. Use the Advance button to scroll through the values. Use the On/Off button to accept a value and move to the next setting.
3. Press and release the On/Off button to exit setup mode.

When the time setting sequence is complete, the device exits Setup mode, automatically displays the alarm settings in effect, and is then ready to begin normal operation.

## Communications

### Serial Output

The Model 2500A provides real-time data output capability via the pulse oximeter sensor connector (a 9-pin Sub-D connector). The pulse oximeter sensor connector pin assignments are listed below.

**Table 5: Pulse Oximeter Sensor Connector Pin Assignments**

Pin Number	Assignment
1	1-Wire <sup>®</sup>
2	Infrared Anode, Red Cathode
3	Infrared Cathode, Red Anode
4	Serial Data, TTL Levels
5	Detector Anode
6	Sensor Type
7	Cable Shield (Ground)
8	No Connection
9	Detector Cathode, +5 V

Information from the device, in the real-time mode, is sent in an ASCII serial format at 9600 baud with 9 data bits, 1 start bit, and 1 stop bit. The data are output at a rate of once per second.

**NOTE:** The 9th data bit is used for odd parity in memory playback mode. In real-time mode, it is always set to the mark condition. Therefore the real-time data may be read as 8 data bits, no parity.

Real-time data may be printed or displayed by devices other than the pulse oximeter. On power up a header is sent identifying the format and the time and date. Thereafter, the data are sent once per second in the following format:

SPO<sub>2</sub>=XXX HR=YYY

where “XXX” represents the SpO<sub>2</sub> value, and “YYY” represents the pulse rate. The SpO<sub>2</sub> and pulse rate will be displayed as “---” if there are no data available for the data reading.

### Connecting the Device into a Medical System

Incorporating the device into a medical system requires the integrator to identify, analyze, and evaluate the risks to patient, operators, and third parties. Subsequent changes to the medical system after device integration could introduce new risks and will require additional analysis. Changes to the medical system that must be evaluated include:

- Changing the system configuration
- Adding devices to or disconnecting devices from the system

- Updating or upgrading equipment connected to the system

Issues resulting from user-initiated system changes may include corruption or loss of data.

---

**NOTES:**

- When using the serial port to connect the device to other equipment, follow each device's cleaning instructions.
- Verify all equipment connected to the device is suitable for the patient's environment.



**CAUTION:** Failure of a network data coupling (serial cable/connectors/wireless connections) will result in loss of data transfer.

## Service, Support and Warranty



**CAUTION:** This device is a precision electronic instrument and must be repaired by trained Nonin personnel only. Field repair of the device is not possible. Do not attempt to open the case or repair the electronics. Opening the case may damage the device and void the warranty.



**CAUTION:** Any sign or evidence of opening the system, field service by non-Nonin personnel, tampering, or any kind of misuse or abuse of the system, shall void the warranty in its entirety.

The advanced digital circuitry within the Model 2500A requires no periodic maintenance or calibration. The device's expected service life is 5 years. *Nonin does not recommend field repair of the Model 2500A.* The circuit board in the Model 2500A is a multi-layer board using very narrow traces. Due to the very small trace size, extreme care must be used when replacing components to prevent permanent, non-repairable damage to the circuit board. Most components are surface-mounted and require special hot-air jet soldering and desoldering equipment. After any repairs are made, the Model 2500A must be tested to ensure correct operation.

Users and/or patients should report adverse events involving their Nonin device to Nonin Medical, Inc. and the competent authority of the EU Member State in which the user and/or patient is established, if applicable.

For additional technical information, contact Nonin's Technical Service department at:

**Nonin Medical, Inc.**

13700 1st Avenue North  
Plymouth, Minnesota 55441 USA  
(800) 356-8874 (USA and Canada)  
+1 (763) 553-9968  
E-mail: [technicalservice@nonin.com](mailto:technicalservice@nonin.com)

**Nonin Medical B.V.**

Doctor Paul Janssenweg 150  
5026 RH Tiburg, Netherlandss  
+31 (0)13 - 45 87 130 (Europe)  
E-mail: [technicalserviceintl@nonin.com](mailto:technicalserviceintl@nonin.com)

[www.nonin.com](http://www.nonin.com)

All non-warranty work shall be done according to Nonin standard rates and charges in effect at the time of delivery to Nonin. All repairs include a complete retest of the Model 2500A using factory test fixtures.

### **Warranty**

For warranty information go to: <http://www.nonin.com/warranty/>

## Parts and Accessories

For more information about Nonin parts and accessories:

- Contact your distributor or Nonin at (800) 356-8874 (USA and Canada), +1 (763) 553 9968, or +31 (0)13 - 87 45 130 (Europe).
- Visit [www.nonin.com](http://www.nonin.com)

Detailed information regarding specified sensor use (patient population, body/tissue, and application) can be found in the respective sensor instructions.

**WARNING: The use of accessories, sensors, cables, and power supplies other than those specified in the Parts and Accessories List may result in increased electromagnetic emission and/or decreased immunity of this device.**

**WARNING: To avoid patient injury, use only with Nonin-branded PureLight<sup>®</sup> pulse oximeter sensors. These sensors are manufactured to meet the accuracy specifications for Nonin Pulse Oximeters. Using other manufacturers' sensors can result in improper pulse oximeter performance.**



## Troubleshooting

Problem	Possible Cause	Possible Solution
<b>The device won't turn on.</b>	The batteries are depleted.	Replace all 4 batteries.
	The batteries are installed incorrectly.	Verify correct battery orientations. Refer to Figure 3: Installing Batteries.
	A metal contact in the battery compartment is missing or damaged.	Contact Nonin Technical Service.
<b>A dash appears in the left digit of the SpO<sub>2</sub> display.</b>	A sensor fault exists. The sensor may have become dislodged from the device or from the patient.	Verify that the sensor is correctly connected to the device and the patient; replace sensor if the condition persists.
<b>The middle digits display dashes in both the SpO<sub>2</sub> and Pulse Rate displays.</b>	No signal is detected because the sensor is not plugged in.	Verify the sensor connections.
	A sensor failure.	Replace the sensor.
<b>The displayed pulse rate does not correlate to the pulse rate displayed on the ECG monitor.</b>	Excessive motion at the sensor site may be prohibiting the device from acquiring a consistent pulse signal.	Eliminate or reduce the cause of the motion artifact <b>or</b> reposition the sensor to a new sensor site where motion is not present.
	The patient may have an arrhythmia resulting in some heart beats that do not yield a pulse quality signal at the sensor site.	Examine the patient: the condition may persist even though both monitors are functioning properly if the patient's arrhythmia persists.
	A non-specified sensor is being used.	Replace the sensor with a Nonin-branded sensor.
	The ECG monitor may not be functioning properly.	Examine the patient: replace the ECG monitor <b>or</b> refer to the operator's manual for the ECG monitor.
<b>An erratic Pulse Rate display and/or an amber Pulse Quality display during the concurrent use of electro-surgical equipment (ESU).</b>	The ESU may be interfering with the pulse oximeter performance.	Examine the patient: move the device, cables, and sensors as far away from the ESU as possible <b>or</b> refer to the ESU operator's manual.

Problem	Possible Cause	Possible Solution
<b>The Pulse Quality display is blinking amber with each pulse.</b>	The quality of the pulse signal at the sensor site is marginal.	Examine the patient: reposition sensor <b>or</b> select an alternate sensor site.
<b>Unable to obtain a green blinking Pulse Quality display.</b>	Low patient pulse strength; <b>or</b> the sensor site is poorly perfused; <b>or</b> the sensor is not correctly positioned.	Reposition the sensor on the patient.
	The sensor is attached too tightly, or tape or other items are restricting the pulse quality at the sensor site.	Reapply the sensor, select an alternate sensor site, or remove the restrictive material from the sensor site.
	Circulation is reduced due to excess pressure between the sensor and a hard surface.	Allow the sensor and finger, foot, etc., to rest comfortably on the surface.
	Excessive ambient light.	Reduce the ambient light.
	Excessive patient motion.	Reduce the patient motion.
	The sensor is applied to a polished finger or toe nail.	Remove the nail polish.
	Interference from: <ul style="list-style-type: none"> <li>• arterial catheter</li> <li>• blood pressure cuff</li> <li>• electrosurgical procedure</li> <li>• infusion line</li> </ul>	Reduce or eliminate the interference.
<b>The Pulse Quality display is blinking red and the SpO<sub>2</sub> and/or Pulse Rate displays show dashes.</b>	An inadequate signal at the sensor site.	Examine the patient: reposition sensor <b>or</b> select an alternate sensor site.
	Excessive motion at the sensor site may be prohibiting the device from acquiring a consistent pulse signal.	Eliminate or reduce the cause of the motion artifact or reposition the sensor to a sensor site where motion is not present.
	A sensor failure.	Replace the sensor.
<b>Segments of the SpO<sub>2</sub> or Pulse Rate displays are missing.</b>	Defective LED displays.	Displayed values may not be reliable; discontinue use of the device.

Problem	Possible Cause	Possible Solution
Err E01, E02, E03, <b>or</b> E04 is displayed.	There is a system fault that must be corrected.	Turn the device off and on. If the problem persists, contact Nonin Technical Service.
<b>Disruption in the device performance.</b>	Electromagnetic interference (EMI).	Remove the device from the EMI environment.
<b>Displays and indicators are off, but a continuous audible alarm is sounding.</b>	There is a system fault that must be corrected.	Turn the device off and on. If the problem persists or the device does not turn on, replace or recharge the batteries. If the problem still persists, contact Nonin Technical Service.

**NOTE:** If these solutions do not correct the problem with your device, please contact Nonin Technical Service at (800) 356-8874 (USA and Canada), +1 (763) 553-9968, or +31 (0)13 - 45 87 130 (Europe).

## Technical Information

**NOTE:** This product complies with ISO 10993-1, Biological Evaluation of Medical Devices Part 1: Evaluation and Testing.



**CAUTION:** A functional tester cannot be used to assess the accuracy of a pulse oximeter monitor or sensor.



**CAUTION:** All parts and accessories connected to the serial port of this device must be certified according to at least IEC Standard EN 60950 or UL 1950 for data-processing equipment.

**WARNING:** Portable RF communications equipment such as cell phones or radios (including peripherals such as antenna cables and external antennas) should be used no closer than 30 cm (12 inches) to any part of the ME system, including cables specified by the manufacturer. Otherwise, degradation of the performance of this equipment could result.

### Manufacturer's Declaration

Refer to the following table for specific information regarding this device's compliance to IEC 60601-1-2.

### Essential Performance

Essential performance of the 2500A is defined as SpO<sub>2</sub> accuracy, pulse rate accuracy, Limit Alarm Conditions or an indication of abnormal operation. Accuracies may be affected as a result of exposure to electromagnetic disturbances that are outside of the environments listed in the *Indications For Use*. If issues are experienced, move the Nonin system away from the source of electromagnetic disturbances.

**Table 6: Electromagnetic Emissions**

<i>This device is intended for use in the electromagnetic environment specified in the Indications for Use section. The user of this device should ensure that it is used in such an environment.</i>	
<b>Emissions Test</b>	<b>Compliance</b>
RF Emissions CISPR 11	Group 1, Class B

**Table 7: Electromagnetic Immunity**

Immunity Test	Compliance	
Electrostatic Discharge (ESD) IEC 61000-4-2	±8 kV contact ±15 kV air	
Power Frequency (50/60 Hz) Magnetic Field IEC 61000-4-8	30 A/m	
Radiated RF IEC 61000-4-3	80 MHz – 2.7 GHz	10 V/m
	380 – 390 MHz	27 V/m
	430 – 470 MHz	28 V/m
	704 – 787 MHz	9 V/m
	800 – 960 MHz	28 V/m
	1.7 – 1.99 GHz	28 V/m
	2.4 – 2.57 GHz	28 V/m
	5.1 – 5.8 GHz	9 V/m

**Table 8: Not Applicable**

*Harmonic Emissions (IEC 61000-3-2), Voltage Flicker Emissions (IEC 61000-3-3), Electrical Fast Transients (IEC 61000-4-4), Surge (IEC 61000-4-5), Voltage dips (IEC 61000-4-11), Conducted Immunity (IEC 61000-4-6)*

**NOTE:** These guidelines may not apply in all situations. Electromagnetic propagation is affected by absorption and reflection from structures, objects, and people.

## Equipment Response Time

If the signal from the sensor is inadequate, the last measured SpO<sub>2</sub> and pulse rate values freeze for 10 seconds and are then replaced with dashes.

SpO <sub>2</sub> Values	Average	Latency
Standard/Fast Averaged SpO <sub>2</sub>	4 beat exponential	2 beats

Pulse Rate Values	Response	Latency
Standard/Fast Averaged Pulse Rate	4 beat exponential	2 beats

Equipment Delays	Delay
Display Update Delay	1.5 seconds
Alarm Signal Generation Delay	0 seconds

### Example - SpO<sub>2</sub> Exponential Averaging

SpO<sub>2</sub> decreases 0.75% per second (7.5% over 10 seconds)

Pulse Rate = 75 BPM Specific to this example:

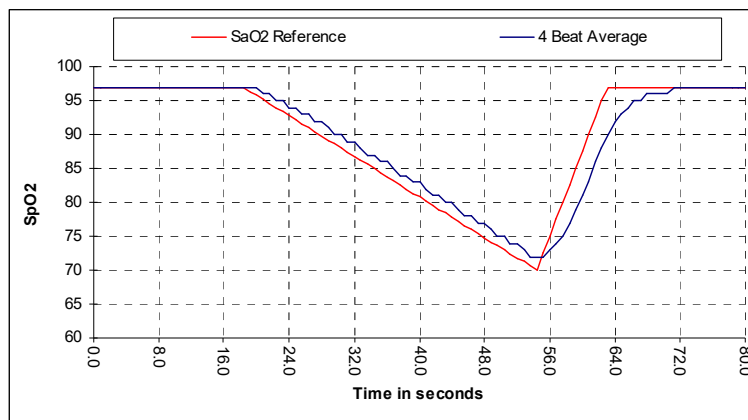

- The response of the 4-beat average is 1.5 seconds.

## **Testing Summary**

SpO<sub>2</sub> accuracy, and low perfusion testing were conducted by Nonin Medical, Inc., as described below:

### **SpO<sub>2</sub> Accuracy Testing**

During motion and no-motion conditions at an independent research laboratory, SpO<sub>2</sub> accuracy testing is conducted during induced hypoxia studies on healthy, male and female, non-smoking, light- to dark-skinned subjects that are 18 years of age and older. The measured arterial hemoglobin saturation value (SpO<sub>2</sub>) of the sensors is compared to arterial hemoglobin oxygen (SaO<sub>2</sub>) value, determined from blood samples with a laboratory co-oximeter. The accuracy of the sensors in comparison to the co-oximeter samples measured over the SpO<sub>2</sub> range of 70 - 100%. Accuracy data is calculated using the root-mean-squared ( $A_{\text{rms}}$  value) for all subjects, per ISO 80601-2-61, Medical Electrical Equipment—Particular requirements for the basic safety and essential performance of pulse oximeter equipment for medical use.

### **Pulse Rate Motion Testing**

This test measures pulse rate oximeter accuracy with motion artifact simulation introduced by a pulse oximeter tester. This test determines whether the oximeter meets the criteria of ISO 80601-2-61 for pulse rate during simulated movement, tremor, and spike motions.

### **Low Perfusion Testing**

This test uses an SpO<sub>2</sub> Simulator to provide a simulated pulse rate, with adjustable amplitude settings at various SpO<sub>2</sub> levels for the oximeter to read. The oximeter must maintain accuracy in accordance with ISO 80601-2-61 for heart rate and SpO<sub>2</sub> at the lowest obtainable pulse amplitude (0.3% modulation).

## **Principles of Operation**

Pulse oximetry is a non-invasive method that passes red and infrared light through perfused tissue and detects the fluctuating signals caused by arterial pulses. Well-oxygenated blood is bright red, while poorly oxygenated blood is dark red. The pulse oximeter determines functional oxygen saturation of arterial hemoglobin (SpO<sub>2</sub>) from this color difference by measuring the ratio of absorbed red and infrared light as volume fluctuates with each pulse.

## Specifications

<b>Oxygen Saturation Display Range</b>	0 to 100% SpO <sub>2</sub>
<b>Pulse Rate Display Range</b>	18 to 321 beats per minute (BPM)
<b>Accuracy – Sensors</b>	Declared accuracy data for compatible sensors can be found in Nonin's Sensor Accuracy document.
<b>Measurement Wavelengths and Output Power*</b>	Red: 660 nanometers @ 0.8 mW maximum avg. Infrared: 910 nanometers @ 1.2 mW maximum avg.
<b>Alarm Volume:</b>	High: 69 dBA Low: 52 dBA
<b>Informational Tone Volume:</b>	High: 65dBA Low: 45dBA
<b>Indicators</b>	Pulse Quality Display: LED, tricolor Numeric Displays: 3-digit 7-segment LEDs, red Low Battery Indicator: LED, amber Alarm Bar: LED, bicolor Alarm Silence Indicator: LED, amber
<b>Temperature</b>	Operating: 0 °C to 40 °C (32 °F to 104 °F) Transient Operating**: -20 °C to 50 °C (-4 °F to 122 °F) Storage/Transportation -40 °C to 70 °C (-40 °F to 158 °F)
<b>Humidity</b>	Humidity (Storage/Transportation): 15% to 93% noncondensing Transient Operating**: 15% to 90% noncondensing Storage/Transportation Up to 93% noncondensing
<b>Altitude (Operating)</b>	Up to 12,000 meters (40,000 feet)
	Altitude (Hyperbaric Pressure): Up to 4 atmospheres
<b>Transition time (from storage) to device ready for its intended use:</b>	Within 2 minutes to warm from -40 °C to -20 °C Within 4 minutes to cool from 70 °C to 50 °C
<b>Power Requirements</b>	Four 1.5V AA-size alkaline batteries (60 hours typical operation) or NiMH rechargeable battery pack (40 hours typical operation)
<b>Dimensions</b>	13.8 cm H x 7.0 cm W x 3.2 cm D (5.4 in H x 2.8 in W x 1.3 in D)
<b>Weight</b>	213 g (7.5 oz) (with alkaline batteries) 233 g (8.2 oz) (with NiMH rechargeable battery pack)



**Classifications per IEC 60601-1 / CAN/CSA-C22.2 No. 601.1 / UL 60601-1**

Type of Protection: Internally powered (on battery power)

Degree of Protection: Type BF-Applied Part

Mode of Operation: Continuous

**Enclosure Degree of Ingress Protection IP32**

\* This information is especially useful for clinicians performing photodynamic therapy.

\*\* The system will operate for a minimum of 20 minutes when exposed to the extreme environmental operating conditions

This device is not made with natural rubber latex.