



# **Operator's Manual**

# **Model 2500 PalmSAT<sup>®</sup>**

**Pulse Oximeter**

**CE 0123**

**English**

**CAUTION: Federal law (USA) restricts this device to sale by or on the order of a licensed practitioner.**



**Consult Instructions for Use.**

Nonin® reserves the right to make changes and improvements to this manual and the products it describes at any time, without notice or obligation.

**Nonin Medical, Inc.**

13700 1st Avenue North  
Plymouth, Minnesota 55441 USA

+1 (763) 553-9968  
(800) 356-8874 (USA and Canada)  
Fax: +1 (763) 553-7807  
E-mail: [info@nonin.com](mailto:info@nonin.com)

**Nonin Medical B.V.**

Prins Hendriklaan 26  
1075 BD Amsterdam, Netherlands

+31 (0)13 - 79 99 040 (Europe)  
Fax: +31 (0)13 - 79 99 042  
E-mail: [infointl@nonin.com](mailto:infointl@nonin.com)

[www.nonin.com](http://www.nonin.com)

**CE 0123**

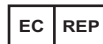

MPS, Medical Product Service GmbH  
Borngasse 20  
D-35619 Braunfels, Germany

References to “Nonin” in this manual shall imply Nonin Medical, Inc.

Nonin, PalmSAT, PureLight and nVISION are registered trademarks or trademarks of Nonin Medical, Inc.

Microsoft® and Windows® are registered trademarks of Microsoft Corporation.

© 2020 Nonin Medical, Inc.  
**7923-001-05**

# Contents

<b>Indications for Use .....</b>	<b>1</b>
Warnings .....	1
Cautions .....	2
<b>Guide to Symbols .....</b>	<b>4</b>
<b>Displays and Indicators .....</b>	<b>6</b>
SpO <sub>2</sub> Display .....	6
Pulse Rate Display .....	6
Pulse Quality Display.....	6
Low Battery Indicator.....	6
Sensor Fault or Inadequate Signal Display .....	6
<b>Using the PalmSAT Pulse Oximeter .....</b>	<b>7</b>
Unpacking the Model 2500.....	8
Installing and Using the Batteries .....	9
Important Notes about Battery Use .....	10
With AA Batteries.....	10
With Rechargeable NiMH Battery Pack .....	10
Recharging Batteries (NiMH Battery Pack only).....	11
Connecting the Sensor .....	11
Power On/Off.....	11
Power On Self-Test .....	11
Monitoring.....	12
<b>Detailed Operation.....</b>	<b>13</b>
Setup Mode .....	13
Entering Setup Mode .....	13
Making Selections in Setup Mode.....	13
<b>Care and Maintenance.....</b>	<b>15</b>
<b>Visual Indicators .....</b>	<b>16</b>
<b>Memory Functions.....</b>	<b>17</b>
Memory Download.....	17
Downloading the Data Stored in Memory .....	17
Clearing the Memory .....	18
Clear Memory Mode .....	18
Choosing Calendar and Clock Settings.....	18
<b>Communications.....</b>	<b>19</b>
Serial Output.....	19
Connecting the Device into a Medical System .....	20
<b>Service, Support and Warranty .....</b>	<b>21</b>
Warranty .....	21

## Contents (Continued)

<b>Parts and Accessories</b> .....	<b>22</b>
<b>Troubleshooting</b> .....	<b>23</b>
<b>Technical Information</b> .....	<b>25</b>
Manufacturer's Declaration .....	25
Essential Performance.....	25
Equipment Response Time.....	27
Testing Summary .....	28
SpO <sub>2</sub> Accuracy Testing .....	28
Pulse Rate Motion Testing.....	28
Low Perfusion Testing .....	28
Principles of Operation.....	28
Specifications .....	29

## Figures

Figure 1. Displays, Indicators and Buttons.....	7
Figure 2. Rear View.....	8
Figure 3. Installing Batteries.....	10
Figure 4. Connecting a Sensor.....	11

## Tables

Table 1. Labeling Symbols.....	4
Table 2. Adjustable Parameters and Settings.....	13
Table 3. Pulse Oximeter Sensor Connector Pin Assignments.....	19
Table 4. Electromagnetic Emissions.....	25
Table 5. Electromagnetic Immunity.....	26
Table 6. Not Applicable.....	26

## Indications for Use

The Nonin<sup>®</sup> Model 2500 Pulse Oximeter is indicated for use in measuring and displaying functional oxygen saturation of arterial hemoglobin (SpO<sub>2</sub>) and pulse rate for adult, pediatric, and neonatal patients. The device is intended for continuous monitoring and/or spot-checking of patients during both motion and no-motion conditions, and for patients who are well or poorly perfused.

## Warnings

Do not use this device in an MR environment.
<b>Explosion Hazard:</b> Do not use in an explosive atmosphere or in the presence of flammable anesthetics or gasses.
This device is not defibrillation proof per IEC 60601-1.
This device is intended only as an adjunct in patient assessment. It must be used in conjunction with other methods of assessing clinical signs and symptoms.
Oximeter readings of this device may be affected by the use of an electrosurgical unit (ESU).
Inspect the sensor application site at least every 6 to 8 hours to ensure correct sensor alignment and skin integrity. Patient sensitivity to sensors and/or double-backed adhesive strips may vary due to medical status or skin condition.
To avoid patient injury, use only with Nonin-branded PureLight <sup>®</sup> pulse oximeter sensors. These sensors are manufactured to meet the accuracy specifications for Nonin Pulse Oximeters. Using other manufacturers' sensors can result in improper pulse oximeter performance.
To prevent improper performance and/or patient injury, verify compatibility of the monitor, sensor(s), and accessories before use.
No modifications to this device are allowed as it may affect device performance.
Do not use a damaged sensor. If the sensor is damaged in any way, discontinue use immediately and replace the sensor.
As with all medical equipment, carefully route patient cabling to reduce the possibility of patient entanglement, strangulation, or injury to the patient.
This device should not be used adjacent to or stacked with other equipment. If adjacent or stacked use is necessary, the device should be observed carefully to verify normal operation.
The use of accessories, sensors, cables, and power supplies other than those specified in the Parts and Accessories List may result in increased electromagnetic emission and/or decreased immunity of this device.
This device must be able to measure the pulse properly to obtain an accurate SpO <sub>2</sub> measurement. Verify that nothing is hindering the pulse measurement before relying on the SpO <sub>2</sub> measurement.
Operation of this device below the minimum amplitude of 0.3% modulation may cause inaccurate results.
Discontinue use of adhesive tape strips if the patient exhibits an allergic reaction to the adhesive material.
Avoid excessive pressure to the sensor application site as this may cause damage to the skin beneath the sensor.

## Warnings (Continued)

The device turns off after approximately 10 minutes when at critically low battery capacity.
Before changing the batteries, make sure the device is off and the sensor is not applied to a digit.
Portable RF communications equipment such as cell phones or radios (including peripherals such as antenna cables and external antennas) should be used no closer than 30 cm (12 inches) to any part of the ME system, including cables specified by the manufacturer. Otherwise, degradation of the performance of this equipment could result.

## Cautions

Before use, carefully read the Instructions for Use provided with the sensors.
This device is not an apnea monitor.
Verify that all visible indicators illuminate during the startup (initialization) sequence. If any indicator is not lit, do not use the device. Contact Nonin Technical Service for assistance.
The presence of a defibrillator may interfere with the performance of this device.
This device may not work on all patients. If you are unable to achieve stable readings, discontinue use.
This device has motion tolerant software that minimizes the likelihood of motion artifact being misinterpreted as good pulse quality. In some circumstances, however, the device may still interpret motion as good pulse quality. Minimize patient motion as much as possible.
Ear Clip and Reflectance sensors are not recommended for pediatric or neonatal use. The accuracy of these sensors has not been established for pediatric or neonatal use.
Do not autoclave or immerse the device or sensors in liquid. Do not expose the device or components to excessive moisture or liquids.
Do not use caustic or abrasive cleaning agents on the device or the sensors.
The oximeter sensor might not work on cold extremities due to reduced circulation. Warm or rub the finger to increase circulation, or reposition the sensor.
Replace the batteries as soon as possible after a low-battery indication. Always replace the batteries with fully charged batteries.
Use only Nonin-specified battery types with this device.
Do not use fully charged and partially charged batteries at the same time. This may cause the batteries to leak.
Do not remove any covers other than the battery cover when replacing batteries. There are no user-serviceable parts inside other than the replaceable batteries.
Follow local, state and national governing ordinances and recycling instructions regarding disposal or recycling of the device and device components, including batteries.
Batteries may leak or explode if used or disposed of improperly.
Remove the batteries if the device will be stored for more than 1 month.















## Cautions (Continued)

<p>This equipment complies with IEC 60601-1-2 for electromagnetic compatibility for medical electrical equipment and/or systems. This standard is designed to provide reasonable protection against harmful interference in a typical medical installation. However, because of the proliferation of radio-frequency transmitting equipment and other sources of electrical noise in healthcare and other environments, it is possible that high levels of such interference due to close proximity or strength of a source might disrupt the performance of this device. Medical electrical equipment needs special precautions regarding EMC, and all equipment must be installed and put into service according to the EMC information specified.</p>
<p>In compliance with the European Directive on Waste Electrical and Electronic Equipment (WEEE) 2002/96/EC, do not dispose of this product as unsorted municipal waste. This device contains WEEE materials; please contact your distributor regarding take-back or recycling of the device. If you are unsure how to reach your distributor, please call Nonin for your distributor's contact information.</p>
<p>This device's display will go blank after 10 seconds of inadequate signals. The data update period is every 1.5 seconds.</p>
<p>This device is designed to determine the percentage of arterial oxygen saturation of functional hemoglobin. Factors that may degrade pulse oximeter performance or affect the accuracy of the measurement include the following:</p> <ul style="list-style-type: none"> <li>- excessive ambient light</li> <li>- excessive motion</li> <li>- electrosurgical interference</li> <li>- blood flow restrictors (arterial catheters, blood pressure cuffs, infusion lines, etc.)</li> <li>- moisture in the sensor</li> <li>- improperly applied sensor</li> <li>- incorrect sensor type</li> <li>- inadequate signal</li> <li>- venous pulsations</li> <li>- anemia or low hemoglobin concentrations</li> <li>- cardiogreen and other intravascular dyes</li> <li>- carboxyhemoglobin</li> <li>- methemoglobin</li> <li>- dysfunctional hemoglobin</li> <li>- artificial nails or fingernail polish.</li> </ul>
<p>A functional tester cannot be used to assess the accuracy of a pulse oximeter monitor or sensor.</p>
<p>All parts and accessories connected to the serial port of this device must be certified according to at least IEC 60950 or UL1950 for data-processing equipment.</p>
<p>This device is a precision electronic instrument and must be repaired by trained Nonin personnel only. Field repair of the device is not possible. Do not attempt to open the case or repair the electronics. Opening the case may damage the device and void the warranty.</p>
<p>Any sign or evidence of opening the system, field service by non-Nonin personnel, tampering, or any kind of misuse or abuse of the system, shall void the warranty in its entirety.</p>
<p>Replace batteries within 30 seconds to avoid losing settings (date, time, and patient data stored in memory) or corrupting data.</p>
<p>Radios and cell phones or similar devices can affect the equipment and must be kept at least 2 meters (6.5 feet) away from equipment.</p>
<p>Failure of a network data coupling (serial cable/connectors/wireless connections) will result in loss of data transfer.</p>



## Guide to Symbols

This table describes the symbols that are found on the Model 2500 and in this manual.

**Table 1: Labeling Symbols**

Symbol	Description
	Caution
	Consult Instructions for Use.
	Follow Instructions for Use.
	Type BF Applied Part (Patient isolation from electrical shock).
	UL Mark for Canada and the United States with respect to electric shock, fire, and mechanical hazards only in accordance with UL 60601-1 and CAN/CSA-C22.2 No. 601.1.
CE 0123	CE Marking indicating conformance to EC directive No. 93/42/EEC concerning medical devices.
	MR Unsafe
<b>SN</b>	Serial Number (located under the back cover).
<b>IP32</b>	Protected against vertically falling water drops when enclosure is tilted up to 15 degrees and ingress of solid foreign objects greater than or equal to 2.5 mm (0.1 in.) in diameter per IEC 60529.
	Indicates separate collection for electrical and electronic equipment (WEEE).
	Authorized Representative in the European Community.
	Manufacturer
<b>%SpO<sub>2</sub></b>	%SpO <sub>2</sub> Display
	Pulse Rate Display
	Pulse Quality Display
	Low Battery LED
	No Alarms

**Table 1: Labeling Symbols**

<b>Symbol</b>	<b>Description</b>
<b>Front Panel Buttons</b>	
	On/Off
	Advance

## Displays and Indicators

### *SpO<sub>2</sub> Display*

The SpO<sub>2</sub> display is the upper numeric display (identified by the %SpO<sub>2</sub> symbol). This 3-digit light-emitting diode (LED) display shows the current oxygen saturation percentage.

### *Pulse Rate Display*

The Pulse Rate display is the lower numeric display (identified by the  symbol). This 3-digit LED display shows the pulse rate in pulses per minute.

### *Pulse Quality Display*

The Pulse Quality display (identified by the  symbol) is a tricolor LED that blinks once for each detected pulse. The Pulse Quality display changes color to indicate changes in the pulse waveform signal that may affect the SpO<sub>2</sub> data. It may blink green, amber or red.

- **Green** indicates a good pulse strength signal.
- **Amber** indicates a marginal pulse strength signal. To improve signal quality, reposition the sensor, try a different sensor type, reduce patient movement, or improve the site's circulation.
- **Red** indicates an inadequate pulse strength signal. While the Pulse Quality display is red, SpO<sub>2</sub> and pulse rate values are not updated. After about 10 seconds, the values are replaced with dashes, indicating that readings are not possible.

### *Low Battery Indicator*

When batteries are critically low, the digital displays will go blank, and the Pulse Quality display will blink amber or red, but not green. After 10 minutes at critically low battery capacity, the pulse oximeter will shut off automatically.

### *Sensor Fault or Inadequate Signal Display*

If the device determines that a sensor fault exists (a sensor disconnect, failure, misalignment or incompatibility with the monitor) or if a pulse oximeter sensor signal is no longer detected, a dash (-) appears in the leftmost position of the SpO<sub>2</sub> display. The readings that are displayed will freeze for 10 seconds if the pulse oximeter sensor fault or the inadequate signal continues.

If the sensor fault or the inadequate signal is not corrected, the frozen readings and the dash in the leftmost position will be replaced by dashes in the middle of both the SpO<sub>2</sub> and the Pulse Rate displays after 10 seconds.

When the sensor fault or the inadequate signal is corrected, the SpO<sub>2</sub> and pulse rate displays will return to normal operation.

## Using the PalmSAT Pulse Oximeter

The Model 2500 PalmSAT is a digital handheld pulse oximeter that displays numerical values for blood oxygen saturation (%SpO<sub>2</sub>) and pulse rate.

This device will typically operate for 80 hours continuously between alkaline battery replacements, or for 40 hours with the Model 2500B Rechargeable NiMH (Nickel Metal Hydride) Battery Pack (optional). The device requires no routine calibration or maintenance other than replacement of alkaline batteries or recharging the optional battery pack with the Model 2500C Charger Stand (refer to the Model 2500C Operator's Manual).

The pulse oximeter determines functional oxygen saturation of arterial hemoglobin (SpO<sub>2</sub>) by measuring the absorption of red and infrared light passing through perfused tissue. Changes in absorption caused by the pulsation of blood in the vascular bed are used to determine oxygen saturation and pulse rate.

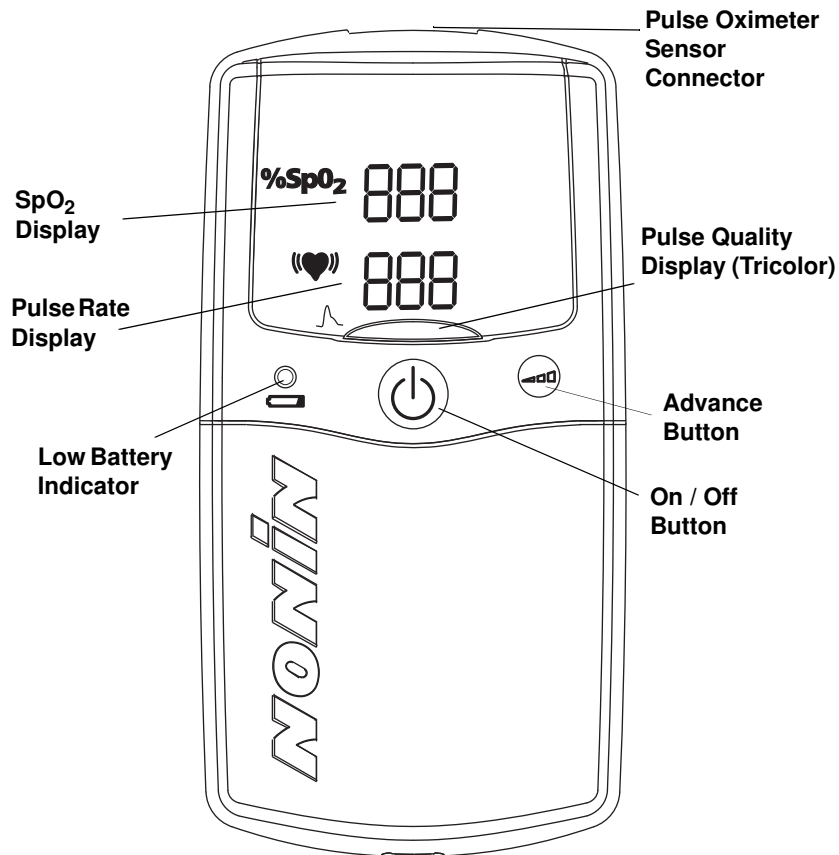
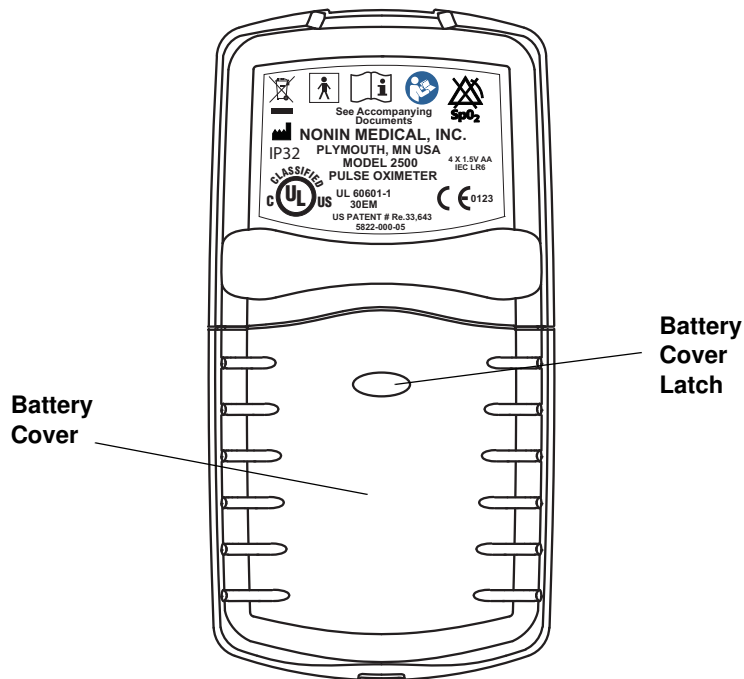

**Figure 1: Displays, Indicators and Buttons**

Oxygen saturation and pulse rate values are displayed by light-emitting diode (LED) digital displays. On each detected pulse, the Pulse Quality display blinks. Patient pulse quality signals are graded as good, marginal, or inadequate and are indicated as such by the Pulse Quality display blinking green, amber or red, respectively. This simple method gives the user a pulse-by-pulse visual indication of waveform signal quality without requiring the user to perform complex waveform analysis.

The Model 2500 Pulse Oximeter may be used with a variety of Nonin-branded PureLight pulse oximeter sensors.

A sensor disconnect or malfunction is indicated by an inadequate Pulse Quality display blinking and/or a dash to the left of the SpO<sub>2</sub> value on the LED display. When adequate pulse signals are not received, the SpO<sub>2</sub> and/or pulse rate numerical values will be replaced by dashes. Low and critically low battery conditions will be indicated by the Low Battery indicator.



**Figure 2: Rear View**

## ***Unpacking the Model 2500***

The Model 2500 complete system includes the following items:

- 1 Model 2500 Pulse Oximeter
- 1 Model 2500 Operator's Manual on CD
- 1 Nonin Pulse Oximeter Sensor
- 4 AA-Size Alkaline Batteries

Confirm that the items listed are packed with the system. If any item on this list is missing or damaged, contact your distributor. Contact the carrier immediately if the shipping carton is damaged.

## ***Installing and Using the Batteries***

The Model 2500 can be powered by 4 AA-size alkaline batteries, or by the optional Rechargeable NiMH Battery Pack, Model 2500B.



**CAUTION:** Use only Nonin-specified battery types with this device.

When batteries are critically low, the digital displays will go blank, and the Pulse Quality display will blink amber or red, but not green. After 10 minutes at critically low battery capacity, the pulse oximeter will shut off automatically.

**WARNING:** The device turns off after approximately 10 minutes when at critically low battery capacity.

**WARNING:** Before changing the batteries, make sure the device is off and the sensor is not applied to a digit.



**CAUTION:** Replace the batteries as soon as possible after a low battery indication. Always replace the batteries with fully charged batteries.

1. Press the battery cover latch, and remove the battery cover on the bottom of the unit.
2. Insert four new AA-size alkaline batteries or a Rechargeable NiMH Battery Pack. Be sure to insert the batteries in the correct position, as indicated by the polarity markings (+ and -) inside the battery compartment. *Proper battery positioning is essential for correct operation.*
3. Replace the battery cover and turn on the device. If the unit does not turn on, see “Troubleshooting.”



**CAUTION:** Replace batteries within 30 seconds to avoid losing settings (date, time, and patient date stored in memory) or corrupting data.

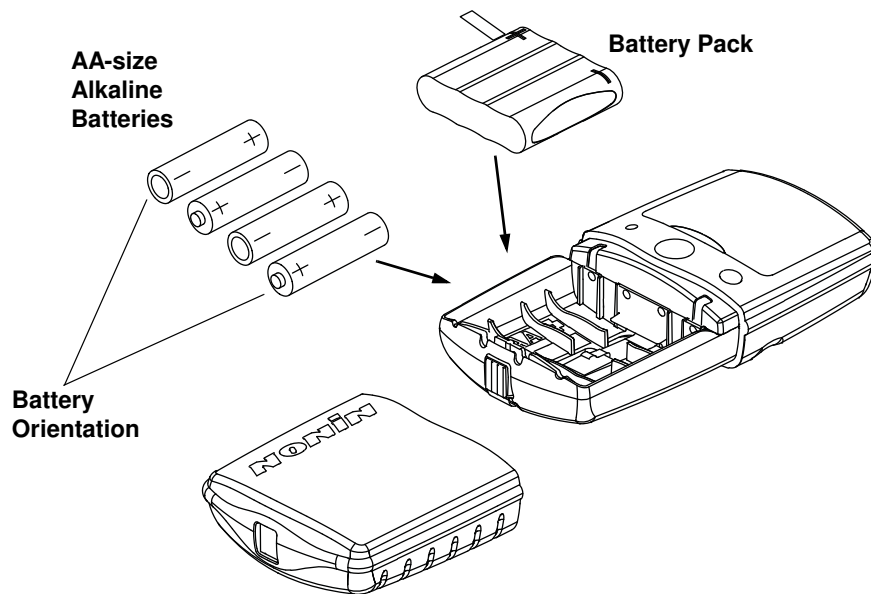

**Figure 3: Installing Batteries**

## ***Important Notes about Battery Use***

Four AA alkaline batteries provide the device with approximately 80 hours of continuous operation, while the Rechargeable NiMH Battery Pack provides approximately 40 hours of continuous operation.

**Clock/calendar settings can significantly affect battery storage life.** Batteries drain during storage, but they drain much more quickly when the unit's clock/calendar functions are set. Refer to "Clock and Calendar Settings" for more information.

### **With AA Batteries**

- If the clock/calendar is *not* set when the unit is stored, alkaline batteries will need replacement in 10-12 months *if the unit has not been used*.
- If the clock/calendar *is* set when the unit is stored and *if the unit has not been used*, alkaline batteries will require replacement in about 6 weeks.
- Using the oximeter will shorten the required replacement time.

### **With Rechargeable NiMH Battery Pack**

- If the clock/calendar is *not* set when the unit is stored, and *if the unit has not been used*, the Rechargeable NiMH Battery Pack will need recharging at least every 2 months.
- If the clock/calendar *is* set when the unit is stored, and *if the unit has not been used*, the Rechargeable NiMH Battery Pack will need recharging at least every 3 weeks.
- Using the oximeter will shorten the required recharging time.



## Recharging Batteries (NiMH Battery Pack only)

- Completely recharging the NiMH battery pack requires approximately 180 minutes when the unit is completely discharged.
- The expected useful life of the Rechargeable NiMH battery pack is 500 charge/discharge cycles, or approximately 10 years, whichever is first. The battery pack must be charged at least once each year to maintain optimal battery life.
- AA alkaline batteries cannot be recharged in the charging stand.

## Connecting the Sensor

Connect the pulse oximeter sensor (with the Nonin logo facing up) to the top of the device as shown. Ensure that the sensor is firmly plugged in. Refer to “Specifications” or to the specific sensor package insert for pulse oximeter sensor positioning information.

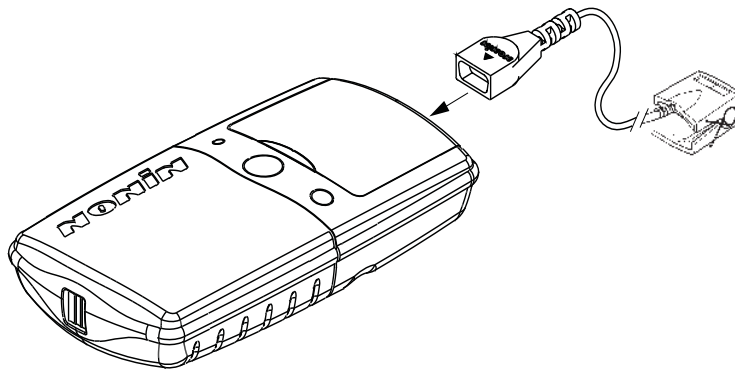

**Figure 4: Connecting a Sensor**

## Power On/Off

- **Turn on** the device by pressing and releasing the On/Off button on the front of the unit.
- **Turn off** the device by pressing and holding the On/Off button for approximately 2 seconds.

To conserve battery life, the device automatically powers off after 10 minutes of inactivity. Inactivity is indicated by dashes on the displays and may result from an improperly connected or positioned sensor, or from an inadequate patient pulse signal.

## Power On Self-Test

When the Model 2500 is turned on for normal operation, the unit will cycle through a startup/initialization sequence before displaying valid data. During startup, always check for any missing indicators or LED display segments. If any indicator is not functioning, do not use the device. Contact Nonin Technical Service for repair or replacement.

During its normal startup sequence, the device will cycle as follows:

- “**▯▯▯ ▯▯▯**” appears briefly in the SpO<sub>2</sub> and Pulse Rate displays.
- the amber Low Battery LED turns on steadily for a few seconds.

- the Pulse Quality display turns red for 1 second, then green for 1 second, then shuts off.
- the clock time currently set in the memory (in hours and minutes, 04 41 for example) appears briefly in the displays.
- the software revision numbers (display in the following order, each for approximately 1 second): Main revision “r” + 3 digit; Memory revision “n” “n” (for m) + 3 digits.
- — (two dashes) appear in the displays until a valid pulse signal is detected.

---

**NOTE:** This startup sequence varies slightly when entering setup mode at power on.

---

## ***Monitoring***



Verify that the pulse oximeter sensor is properly positioned on the patient. Ensure that the pulse oximeter is sensing adequate pulse quality by:

- verifying that the Pulse Quality display is blinking green *and*
- verifying that the Pulse Rate and SpO<sub>2</sub> displays are displaying readings *and*
- verifying that blinking of the Pulse Quality display is in time with the pulse rate for at least 10 seconds

If the Pulse Quality display is blinking red or amber or is blinking erratically, reposition the sensor or replace the sensor.

If the sensor is not properly positioned, or no sensor is attached to the pulse oximeter after startup (a few seconds after powering on), both the SpO<sub>2</sub> and Pulse Rate displays will display a single dash until a valid pulse signal is detected.

## Detailed Operation

All functions of the Model 2500 are controlled by the **On/Off**  and **Advance**  buttons located on the front of the unit.

### Setup Mode

Setup mode is used to set:

1. memory clear function,
2. calendar and clock, and
3. memory playback function.





In Setup mode, the **Advance** and **On/Off** buttons are used to make all selections.

---

**NOTE:** Setting the month to “00” disables the calendar and clock functions and helps conserve battery life.

---

### Entering Setup Mode

1. With the unit off, press and hold the **Advance** button while pressing and then releasing the **On/Off** button.
2. Release the advance button when   is displayed on the SpO<sub>2</sub> and Pulse Rate displays. The clock time currently set in the memory,  4 4  for example, appears briefly in the displays, and then CLr no appears.

### Making Selections in Setup Mode

1. When entering Setup mode, CLr no is displayed. (This indicates the memory clear setting is being adjusted, and that the default value is “no.” See Table 2.) Press and release the **Advance** button to change the value for this setting (or press and hold the Advance button to scroll quickly through the range of adjustable values).
2. When the desired value appears, press and release the **On/Off** button to store the value and advance to the next adjustable parameter, as listed in the following table.
3. Continue this process until all settings are chosen.

When the setting sequence is complete, the device exits Setup mode, and is then ready to begin normal operation.

**Table 2: Adjustable Parameters and Settings**

Setting	Appears in SpO <sub>2</sub> Display	Range of Values Appears in Pulse Rate Display	Default Value
Memory Clear <sup>a</sup>	CLr	yes or no	no
Delete (confirm clear)	dEL	yes or no	no

**Table 2: Adjustable Parameters and Settings (Continued)**

<b>Setting</b>	<b>Appears in SpO<sub>2</sub> Display</b>	<b>Range of Values Appears in Pulse Rate Display</b>	<b>Default Value</b>
Year	y	00 - 99	07
Month	nn	00 - 12	00
Day	d	01 - 31	00
Hour	h	00 - 23	00
Minute	nn	00 - 59	00

a. Choosing “yes” for both the CLr and dEL settings (the memory clear function) will clear the memory and exit setup mode.

## Care and Maintenance

Clean the device separately from the sensors. For instructions on cleaning pulse oximeter sensors, refer to the respective sensor instructions for use.

The Oxitest<sup>Plus7</sup> by Datrend Systems, Inc. can be used to verify operation of the pulse oximeter.



**CAUTION:** Do not autoclave or immerse the device or sensors in liquid. Do not expose the device or components to excessive moisture or liquids.



**CAUTION:** Do not use caustic or abrasive cleaning agents on the device or the sensors.

Clean the device with a soft cloth dampened with isopropyl alcohol. Do not pour or spray any liquids onto the device, and do not allow any liquid to enter any openings in the device. Allow the device to dry thoroughly before reusing.

## Visual Indicators

The intended operator's position for correctly perceiving a visual signal and its priority is 1 meter (3.3 feet).

The following table describes visual indicators and conditions.

Condition	Visible Indication
Pulse Waveform Signal is inadequate	<ul style="list-style-type: none"> <li>• Pulse Quality <b>LED blinks</b> red</li> <li>• SpO<sub>2</sub> and heart rate LEDs display <b>dashes</b> after 10 seconds</li> </ul>
Sensor fault (i.e., sensor disconnect, failure, or incompatibility with the monitor)	<ul style="list-style-type: none"> <li>• Pulse Quality LED <b>blinks</b></li> <li>• <b>Dash (-)</b> appears in the leftmost position of the SpO<sub>2</sub> display</li> <li>• SpO<sub>2</sub> and Heart Rate numeric displays <b>freeze</b> for 10 seconds</li> </ul>
Inadequate Signal (Sensor misalignment, ambient light, nail polish/artificial nails, etc.)	<ul style="list-style-type: none"> <li>• Pulse Quality <b>LED is blank</b></li> <li>• <b>Dash (-)</b> appears in the leftmost position of the SpO<sub>2</sub> display</li> <li>• SpO<sub>2</sub> and Heart Rate numeric <b>displays freeze</b> for 10 seconds</li> </ul>
Inadequate SpO <sub>2</sub> or pulse rate data (excessive motion or erratic heart rate, etc.) more than 20 seconds	<ul style="list-style-type: none"> <li>• <b>Dash (-)</b> appears in SpO<sub>2</sub> and pulse rate displays</li> </ul>
Pulse rate data not updated for more than 30 seconds	<ul style="list-style-type: none"> <li>• Pulse rate numeric display becomes <b>dashes</b></li> </ul>
Low Battery	<ul style="list-style-type: none"> <li>• Low Battery indicator is <b>solid amber LED</b>. No other displays are affected.</li> </ul>
Critically Low Battery	<ul style="list-style-type: none"> <li>• Critically Low Battery <b>indicator is flashing</b></li> <li>• SpO<sub>2</sub> and pulse rate <b>LEDs are blank</b></li> <li>• Pulse Quality display is <b>solid red or amber</b></li> </ul>

## Memory Functions

Each time the Model 2500 is turned on (except during Setup mode), data are automatically collected in memory. The device can collect and store up to 72 hours of SpO<sub>2</sub> and pulse rate information.

---

**NOTE:** Only recording sessions longer than 1 minute are stored in memory. Memory will clear approximately 30 seconds after removing the batteries. Replace batteries immediately to avoid losing stored data.

---

Nonin's nVISION data management software is available for use with Microsoft Windows operating systems.

The memory in the device functions as an "endless loop." When the memory fills up, the unit begins overwriting the oldest data with the newest.

Each time the device is turned on, the current time/date information (if the clock is set correctly) is stored in memory to allow quick differentiation of recording sessions. Patient SpO<sub>2</sub> and pulse rate are sampled and stored every 4 seconds.

Oxygen saturation values are stored in 1% increments in the range of 0 to 100%.

The stored pulse rate ranges from 18 to 300 pulses per minute. The stored values are in increments of 1 pulse per minute in the interval from 18 to 200 pulses per minute, and increments of 2 pulses per minute in the interval from 201 to 300 pulses per minute.

The last data recorded will be the first data printed. For example, the last 4 minutes of data recorded would be the first 4 minutes of printout.





### *Memory Download*

---

**NOTE:** Downloading the data in memory does not clear the memory.

---

### Downloading the Data Stored in Memory

1. With the unit off, press and hold the **Advance** button  while pressing and then releasing the **On/Off** button .
2. Release the advance button when   is displayed on the SpO<sub>2</sub> and pulse rate displays. The clock time currently set in the memory (04 41 for example) appears briefly in the displays, and then CLr no appears.
3. Data will be automatically downloaded from memory. Data is downloaded at a rate of 20 minutes of collected data per second. A 72-hour recording session (the maximum memory saved) is downloaded in approximately 3.5 minutes.
4. After downloading is complete, the device should be shut off before collecting new patient data.
5. The patient data is held in memory as long as the batteries are sufficiently charged. (See "Clearing the Memory" section.) To clear memory, use the memory clear function.

## ***Clearing the Memory***

The Memory Clear function allows you to delete all data currently stored in memory.

### **Clear Memory Mode**

1. Enter Setup mode; **CLr no** will be displayed.
2. **CLr** may be set to **no** or **yES**.
  - If **no** is entered in response to **CLr** (indicating that you do not want to clear the memory), the setup mode will continue directly to the calendar and clock settings. (Refer to “Clock and Calendar Settings.”)
  - If **yES** is entered in response to **CLr**, then **dEL** will next appear in the SpO<sub>2</sub> display, again with a choice of **no** or **yES**. This prompt gives you a second opportunity to avoid clearing the memory.
  - Select **CLr**; use the Advance button to scroll through the values.
  - Use the On/Off button to accept a value and move to the next setting.
3. **dEL** may be set to **no** or **yES**.
  - If **no** is entered in response to **dEL** (indicating that you **do not** want to clear the memory), the setup mode will continue directly to the calendar and clock settings. (Refer to “Choosing Calendar and Clock Settings.”)
  - If **yES** is entered in response to **dEL**, (confirming that you **do** want to clear the memory), then **dnE CLr** will briefly appear in the displays indicating that the memory is cleared. The device will exit setup mode and is ready to begin normal operation.
  - Select **dEL**; use the Advance button to scroll through the values.
  - Use the On/Off button to accept a value and move to the next setting.

## ***Choosing Calendar and Clock Settings***

---

**NOTE:** Setting the month to “00” disables the calendar and clock functions and helps conserve battery life.

---

1. After selecting **no** in the clear memory mode, **y** will appear in the SpO<sub>2</sub> display.
2. Select the year, month, day, hour, and minute by scrolling the Advance button through the values. Use the On/Off button to accept a value and move to the next setting.
3. Press and release the On/Off button to exit setup mode.

When the calendar and clock settings are complete, the device exits Setup mode, and is then ready to begin normal operation.



## Communications

### Serial Output

The Model 2500 provides real-time data output capability via the pulse oximeter sensor connector (a 9-pin Sub-D connector). The pulse oximeter sensor connector pin assignments are listed below.

**Table 3: Pulse Oximeter Sensor Connector Pin Assignments**

Pin Number	Assignment
1	1-Wire <sup>®</sup>
2	Infrared Anode, Red Cathode
3	Infrared Cathode, Red Anode
4	Serial Data, TTL Levels
5	Detector Anode
6	Sensor Type
7	Cable Shield (Ground)
8	No Connection
9	Detector Cathode, +5 V

Information from the device, in the real-time mode, is sent in an ASCII serial format at 9600 baud with 9 data bits, 1 start bit, and 1 stop bit. The data are output at a rate of once per second.

---

**NOTE:** The 9th data bit is used for odd parity in memory download. In real-time mode, it is always set to the mark condition. Therefore, real-time data may be read as 8 data bits, no parity.

---

Real-time data may be printed or displayed by devices other than the pulse oximeter. On power up a header is sent identifying the format and the date and time. Thereafter, the data are sent once per second in the following format:

SPO2=XXX HR=YYY

where “XXX” represents the SpO<sub>2</sub> value, and “YYY” represents the pulse rate. The SpO<sub>2</sub> and pulse rate will be displayed as “---” if there are no data available for the data reading.

## ***Connecting the Device into a Medical System***

Incorporating the device into a medical system requires the integrator to identify, analyze, and evaluate the risks to patient, operators, and third parties. Subsequent changes to the medical system after device integration could introduce new risks and will require additional analysis. Changes to the medical system that must be evaluated include:

- Changing the system configuration
- Adding devices to or disconnecting devices from the system
- Updating or upgrading equipment connected to the system

Issues resulting from user-initiated system changes may include corruption or loss of data.

---

### **NOTES:**

- When using the serial port to connect the device to other equipment, follow each device's cleaning instructions.
- Verify all equipment connected to the device is suitable for the patient's environment.



**CAUTION:** Failure of a network data coupling (serial cable/connectors/wireless connections) will result in loss of data transfer.

## Service, Support and Warranty



**CAUTION:** This device is a precision electronic instrument and must be repaired by trained Nonin personnel only. Field repair of the device is not possible. Do not attempt to open the case or repair the electronics. Opening the case may damage the device and void the warranty.



**CAUTION:** Any sign or evidence of opening the system, field service by non-Nonin personnel, tampering, or any kind of misuse or abuse of the system, shall void the warranty in its entirety.

The advanced digital circuitry within the Model 2500 requires no periodic maintenance or calibration. The device's expected service life is 5 years. *Nonin does not recommend field repair of the Model 2500.* The circuit board in the Model 2500 is a multi-layer board using very narrow traces. Due to the very small trace size, extreme care must be used when replacing components to prevent permanent, non-repairable damage to the circuit board. Most components are surface-mounted and require special hot-air jet soldering and desoldering equipment. After any repairs are made, the Model 2500 must be tested to ensure correct operation.

For additional technical information, contact Nonin's Technical Service department at:

**Nonin Medical, Inc.**

13700 1st Avenue North  
Plymouth, Minnesota 55441 USA

(800) 356-8874 (USA and Canada)  
+1 (763) 553-9968  
Fax: +1 (763) 553-7807  
E-mail: [technicalservice@nonin.com](mailto:technicalservice@nonin.com)

**Nonin Medical B.V.**

Prins Hendriklaan 26  
1075 BD Amsterdam, Netherlands

+31 (0)13 - 79 99 040 (Europe)  
Fax: +31 (0)13 - 79 99 042  
E-mail: [technicalserviceintl@nonin.com](mailto:technicalserviceintl@nonin.com)

[www.nonin.com](http://www.nonin.com)

All non-warranty work shall be done according to Nonin standard rates and charges in effect at the time of delivery to Nonin. All repairs include a complete retest of the Model 2500 using factory test fixtures.

### **Warranty**

For warranty information go to: <http://www.nonin.com/warranty/>

## Parts and Accessories

For more information about Nonin parts and accessories:

- See the Parts and Accessories List on the Operator's Manual CD.
- Contact your distributor or Nonin at (800) 356-8874 (USA and Canada), +1 (763) 553-9968, or +31 (0)13 - 79 99 040 (Europe).
- Visit [www.nonin.com](http://www.nonin.com)

Detailed information regarding specific sensor use (patient population, body/tissue, and application) can be found in the respective sensor Instructions for Use.

**WARNING: The use of accessories, sensors, cables, and power supplies other than those specified in the Parts and Accessories List may result in increased electromagnetic emission and/or decreased immunity of this device.**

**WARNING: To avoid patient injury, use only with Nonin-branded PureLight<sup>®</sup> pulse oximeter sensors. These sensors are manufactured to meet the accuracy specifications for Nonin Pulse Oximeters. Using other manufacturers' sensors can result in improper pulse oximeter performance.**

## Troubleshooting

Problem	Possible Cause	Possible Solution
<b>The device won't turn on.</b>	The batteries are depleted.	Replace all 4 batteries.
	The batteries are installed incorrectly.	Verify battery orientation, illustrated inside the battery compartment or in Figure 3: Installing Batteries section of this operator's manual.
	A metal contact in the battery compartment is missing or damaged.	Contact Nonin Technical Service.
<b>A dash appears in the leftmost position of the SpO<sub>2</sub> display.</b>	A sensor fault exists (disconnect, failure, misalignment, or incompatibility with the monitor).	Verify that the sensor is correctly connected to the device and the patient; replace sensor if the condition persists.
<b>Dashes are displayed in both the SpO<sub>2</sub> and Pulse Rate displays.</b>	No signal is detected because the sensor is not plugged in.	Verify the sensor connections.
	Sensor failure.	Replace the sensor.
<b>The displayed pulse rate does not correlate to the pulse rate displayed on the ECG monitor.</b>	Excessive motion at the sensor site may be prohibiting the device from detecting a consistent pulse signal.	Eliminate or reduce the cause of the motion <u>or</u> reposition the sensor to a new sensor site.
	The patient may have an arrhythmia resulting in some heart beats that do not detect a pulse quality signal at the sensor site.	Assess the patient.
	A non-compatible sensor is being used.	Replace the sensor with a Nonin-branded PureLight sensor.
	The ECG monitor may not be functioning properly.	Assess the patient.
<b>An erratic Pulse Rate or an amber Pulse Quality display during the use with electro-surgical unit (ESU).</b>	The ESU may be interfering with the pulse oximeter performance.	Assess the patient. Move the device, cables, and sensors as far away from the ESU as possible.

Problem	Possible Cause	Possible Solution
<b>The Pulse Quality display is blinking amber with each pulse.</b>	The quality of the pulse signal at the sensor site is inadequate.	Assess the patient. Reposition sensor <b>or</b> select an alternate sensor site.
<b>Numeric display segments are missing.</b>	Defective LEDs.	Discontinue use of the device.
<b>Degradation of device performance.</b>	Electromagnetic interference (EMI).	Remove the device from the EMI environment.
<b>Pulse Quality display does not blink green.</b>	Inadequate pulse signal <b>or</b> the sensor is not correctly positioned.	Reposition the sensor.
	The sensor is restricting blood circulation at the sensor site.	Remove the restriction to increase blood circulation at the sensor site <b>or</b> relocate the sensor.
	Excessive ambient light.	Reduce ambient light.
	Excessive patient motion.	Reduce patient motion.
	The patient is wearing nail polish or artificial nails.	Remove nail polish or artificial nails.
	Performance degradation from: <ul style="list-style-type: none"> <li>• arterial catheter</li> <li>• blood pressure cuff</li> <li>• infusion line</li> </ul>	Reduce or eliminate the source.
<b>The Pulse Quality display is blinking red and the SpO<sub>2</sub> and/or Pulse Rate displays are dashes.</b>	Inadequate signal at sensor site.	Assess the patient. Reposition sensor <b>or</b> select an alternate sensor site.
	Inadequate pulse signal due to excessive motion.	Reduce patient motion. Reposition <b>or</b> relocate the sensor.
	Sensor failure.	Replace the sensor.

**Note:** If these solutions do not correct the problem with your device, please contact Nonin Technical Service at (800) 356-8874 (USA and Canada) or +1 (763) 553-9968, or +31 (0)13 - 79 99 040 (Europe).

## Technical Information

**NOTE:** This product complies with ISO 10993-1, Biological Evaluation of Medical Devices Part 1: Evaluation and Testing.



**CAUTION:** A functional tester cannot be used to assess the accuracy of a pulse oximeter monitor or sensor.



**CAUTION:** All parts and accessories connected to the serial port of this device must be certified according to at least IEC Standard EN 60950 or UL 1950 for data-processing equipment.

**WARNING:** Portable RF communications equipment such as cell phones or radios (including peripherals such as antenna cables and external antennas) should be used no closer than 30 cm (12 inches) to any part of the ME system, including cables specified by the manufacturer. Otherwise, degradation of the performance of this equipment could result.

### ***Manufacturer's Declaration***

Refer to the following table for specific information regarding this device's compliance to IEC 60601-1-2.

### **Essential Performance**

Essential performance of the 2500 is defined as SpO<sub>2</sub> accuracy and pulse rate accuracy or an indication of abnormal operation. Accuracies may be affected as a result of exposure to electromagnetic disturbances that are outside of the environments listed in the *Indications For Use*. If issues are experienced, move the Nonin system away from the source of electromagnetic disturbances.

**Table 4: Electromagnetic Emissions**

<i>This device is intended for use in the electromagnetic environment specified in the Indications for Use section. The user of this device should ensure that it is used in such an environment.</i>	
<b>Emissions Test</b>	<b>Compliance</b>
RF Emissions CISPR 11	Group 1, Class B

**Table 5: Electromagnetic Immunity**

Immunity Test	Compliance	
Electrostatic Discharge (ESD) IEC 61000-4-2	±8 kV contact ±15 kV air	
Power Frequency (50/60 Hz) Magnetic Field IEC 61000-4-8	30 A/m	
Radiated RF IEC 61000-4-3	80 MHz – 2.7 GHz	10 V/m
	380 – 390 MHz	27 V/m
	430 – 470 MHz	28 V/m
	704 – 787 MHz	9 V/m
	800 – 960 MHz	28 V/m
	1.7 – 1.99 GHz	28 V/m
	2.4 – 2.57 GHz	28 V/m
	5.1 – 5.8 GHz	9 V/m

**Table 6: Not Applicable**

*Harmonic Emissions (IEC 61000-3-2), Voltage Flicker Emissions (IEC 61000-3-3), Electrical Fast Transients (IEC 61000-4-4), Surge (IEC 61000-4-5), Voltage dips (IEC 61000-4-11), Conducted Immunity (IEC 61000-4-6)*

**NOTE:** These guidelines may not apply in all situations. Electromagnetic propagation is affected by absorption and reflection from structures, objects, and people.



## Equipment Response Time

If the signal from the sensor is inadequate, the last measured SpO<sub>2</sub> and pulse rate values freeze for 10 seconds and are then replaced with dashes.

SpO <sub>2</sub> Values	Average	Latency
Standard/Fast Averaged SpO <sub>2</sub>	4 beat exponential	2 beats

Pulse Rate Values	Response	Latency
Standard/Fast Averaged Pulse Rate	4 beat exponential	2 beats

Equipment Delays	Delay
Display Update Delay	1.5 seconds

### Example - SpO<sub>2</sub> Exponential Averaging

SpO<sub>2</sub> decreases 0.75% per second (7.5% over 10 seconds)

Pulse Rate = 75 BPM Specific to this example:

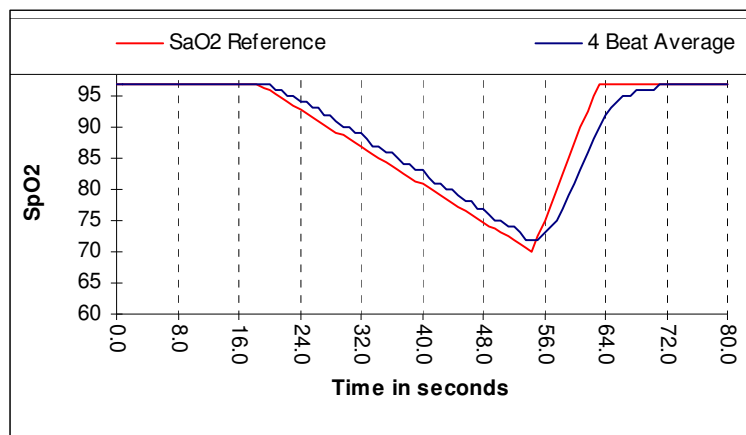

- The response of the 4-beat average is 1.5 seconds.

## ***Testing Summary***

SpO<sub>2</sub> accuracy, and low perfusion testing was conducted by Nonin Medical, Inc., as described below:

### **SpO<sub>2</sub> Accuracy Testing**

During motion and no-motion conditions at an independent research laboratory, SpO<sub>2</sub> accuracy testing is conducted during induced hypoxia studies on healthy, male and female, non-smoking, light- to dark-skinned subjects that are 18 years of age and older. The measured arterial hemoglobin saturation value (SpO<sub>2</sub>) of the sensors is compared to arterial hemoglobin oxygen (SaO<sub>2</sub>) value, determined from blood samples with a laboratory co-oximeter. The accuracy of the sensors in comparison to the co-oximeter samples measured over the SpO<sub>2</sub> range of 70 - 100%. Accuracy data is calculated using the root-mean-squared ( $A_{rms}$  value) for all subjects, per ISO 80601-2-61, Medical Electrical Equipment—Particular requirements for the basic safety and essential performance of pulse oximeter equipment for medical use.

### **Pulse Rate Motion Testing**

This test measures pulse rate oximeter accuracy with motion artifact simulation introduced by a pulse oximeter tester. This test determines whether the oximeter meets the criteria of ISO 80601-2-61 for pulse rate during simulated movement, tremor, and spike motions.

### **Low Perfusion Testing**

This test uses an SpO<sub>2</sub> Simulator to provide a simulated pulse rate, with adjustable amplitude settings at various SpO<sub>2</sub> levels for the oximeter to read. The oximeter must maintain accuracy in accordance with ISO 80601-2-61 for heart rate and SpO<sub>2</sub> at the lowest obtainable pulse amplitude (0.3% modulation).

## ***Principles of Operation***

Pulse oximetry is a non-invasive method that passes red and infrared light through perfused tissue and detects the fluctuating signals caused by arterial pulses. Well-oxygenated blood is bright red, while poorly oxygenated blood is dark red. The pulse oximeter determines functional oxygen saturation of arterial hemoglobin (SpO<sub>2</sub>) from this color difference by measuring the ratio of absorbed red and infrared light as volume fluctuates with each pulse.

## Specifications

<b>Oxygen Saturation Display Range</b>	0 to 100% SpO <sub>2</sub>
<b>Pulse Rate Display Range</b>	18 to 321 beats per minute (BPM)
<b>Accuracy – Sensors</b>	Declared accuracy data for compatible sensors can be found in Nonin’s Sensor Accuracy document.
<b>Measurement Wavelengths and Output Power*</b>	<p>Red: 660 nanometers @ 0.8 mW max. avg.</p> <p>Infrared: 910 nanometers @ 1.2 mW max. avg.</p>
<b>Indicators</b>	<p>Pulse Quality Display: LED, tricolor</p> <p>Numeric Displays: 3-digit 7-segment LEDs, red</p> <p>Low Battery Indicator: LED, amber</p>
<b>Temperature (Operating)</b>	-20 to +50 °C (-4 to +122 °F)
	Temperature (Storage/Transportation): -40 to +70 °C (-40 to +158 °F)
<b>Humidity (Operating)</b>	10 to 95% noncondensing
	Humidity (Storage/Transportation): 10 to 95% noncondensing
<b>Altitude (Operating)</b>	Up to 12,000 meters (40,000 feet)
	Altitude (Hyperbaric Pressure): Up to 4 atmospheres
<b>Power Requirements</b>	Four 1.5V AA-size alkaline batteries (80 hours typical operation) or NiMH rechargeable battery pack (40 hours typical operation)
<b>Dimensions</b>	13.8 cm H x 7.0 cm W x 3.2 cm D (5.4 in H x 2.8 in W x 1.3 in D)
<b>Weight</b>	210 g (7.4 oz) (with alkaline batteries) 230 g (8.1 oz) (with NiMH rechargeable battery pack)
<b>Classifications per IEC 60601-1 / CAN/CSA-C22.2 No. 601.1 / UL60601-1</b>	<p>Type of Protection: Internally powered (on battery power)</p> <p>Degree of Protection: Type BF-Applied Part</p> <p>Mode of Operation: Continuous</p>
<b>Enclosure Degree of Ingress Protection</b>	IP32

\* This information is especially useful for clinicians performing photodynamic therapy.

This device is not made with natural rubber latex.